

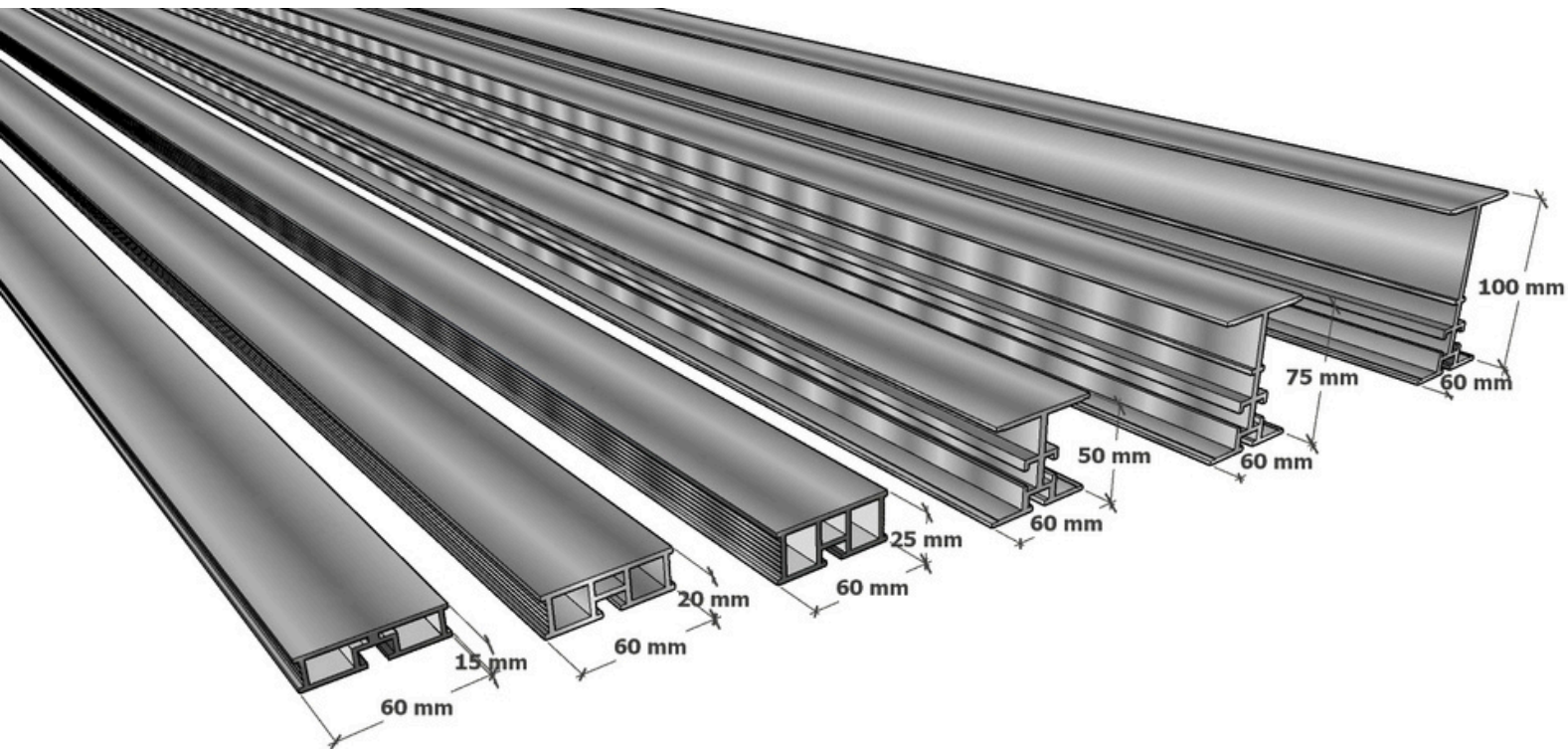

Operations & Maintenance Manual

Aluminium Box Rails & I-Plus Beams



Class A Fire Rated Aluminium 6063 T6

Wallbarn Ltd
Unit 16 Capital Business Centre
22 Carlton Road, South Croydon. CR2 0BS

IMS.T.433.v5

Phone : 0208 916 2222 Email : sales@wallbarn.com Website : www.wallbarn.com







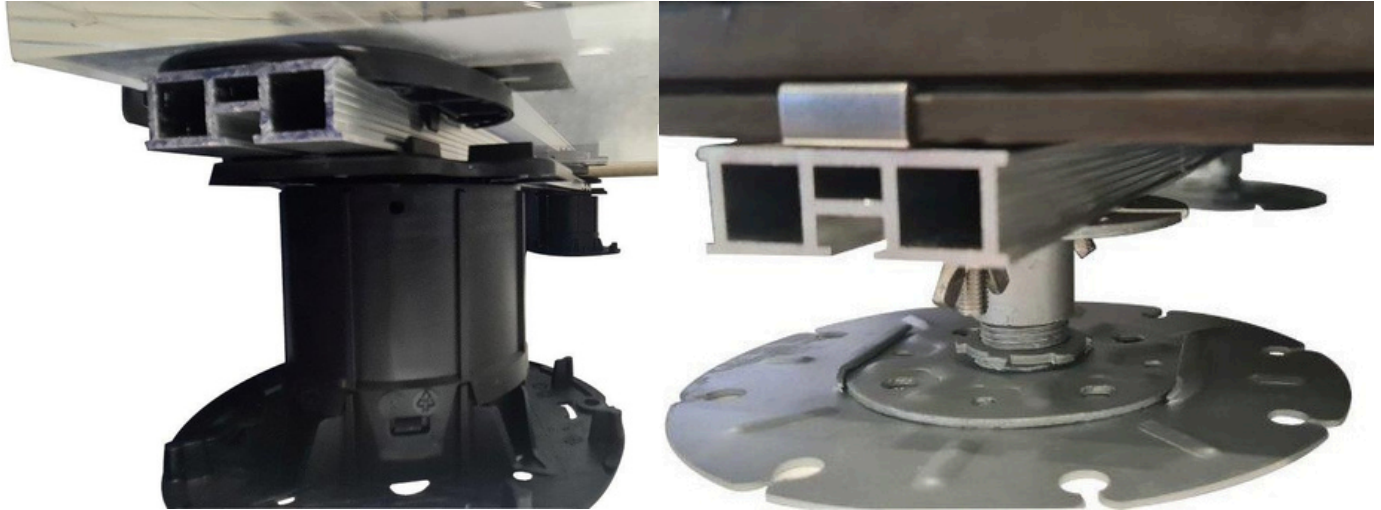

PRODUCT DESCRIPTION

Wallbarn Aluminium Rails/Joists are made from high grade extruded aluminium. They were designed by Wallbarn and made here in the United Kingdom. They are suited to both paving and decking applications and work seamlessly with our plastic and non-combustible pedestals.



PHYSICAL & CHEMICAL PROPERTIES

	15mm Box Rail	20mm Box Rail	25mm Box Rail	50mm I- Plus Beam	75mm I-Plus Beam	100mm I- Plus Beam
Profile						
Material	ALUMINIUM 6063 T6					
Fire Classification	Class A1 BS EN 13501-1 2018					
Weight	0.90kg/m	0.99kg/m	1.99kg/m	1.61kg/m	1.92kg/m	2.19kg/m
Height	15mm	20mm	25mm	50mm	75mm	100mm
Length	2,500mm	2,500mm	2,500mm	3,600mm	3,600mm	3,600mm

Wallbarn Ltd
Unit 16 Capital Business Centre
22 Carlton Road, South Croydon. CR2 0BS

IMS.T.433.v5

Phone : 0208 916 2222 Email : sales@wallbarn.com Website : www.wallbarn.com

Box Rail Profiles

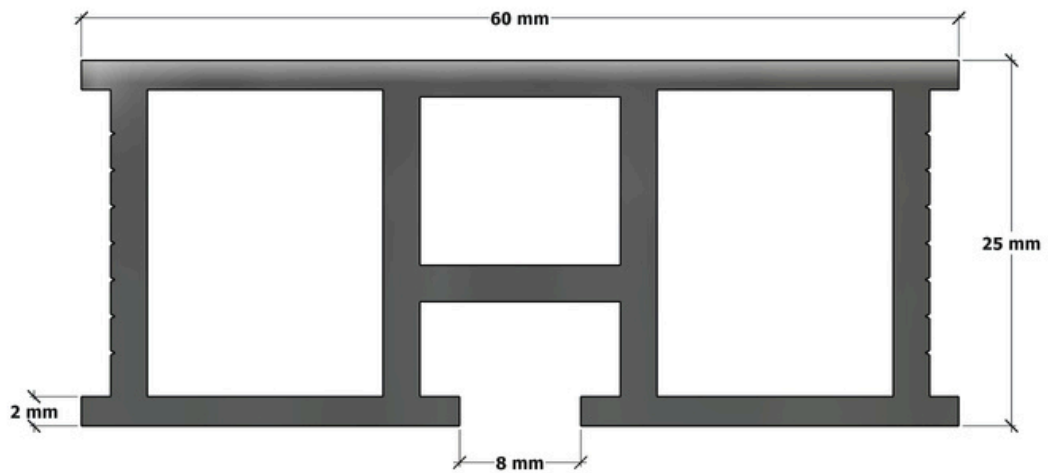
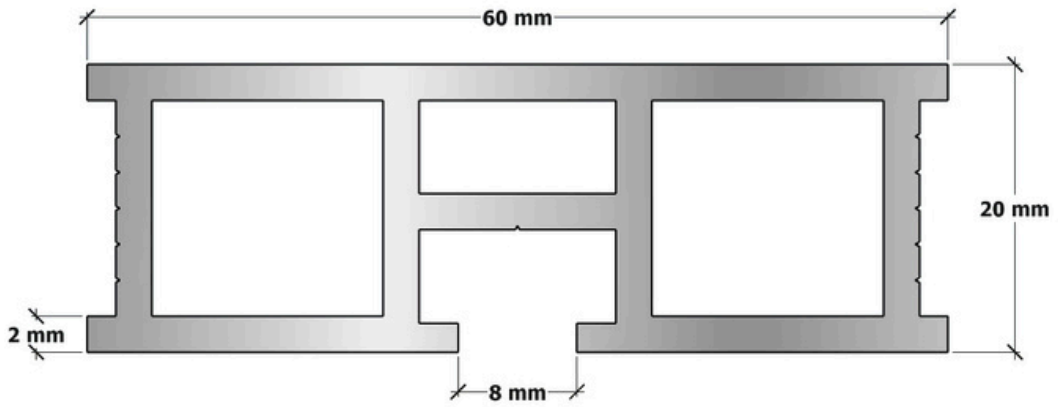
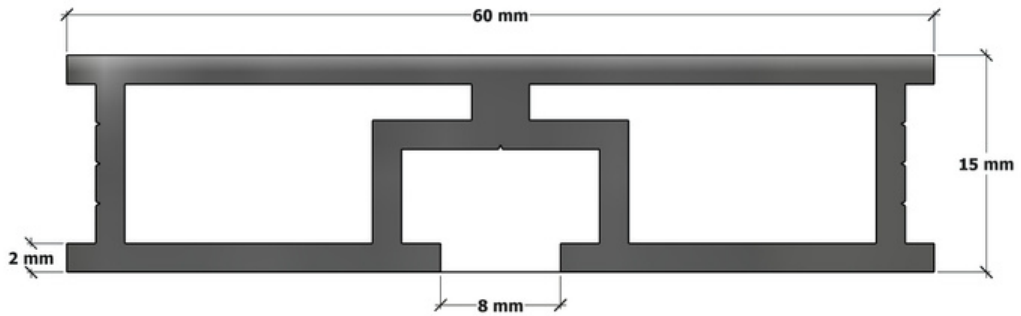

I-Plus Beam Profiles

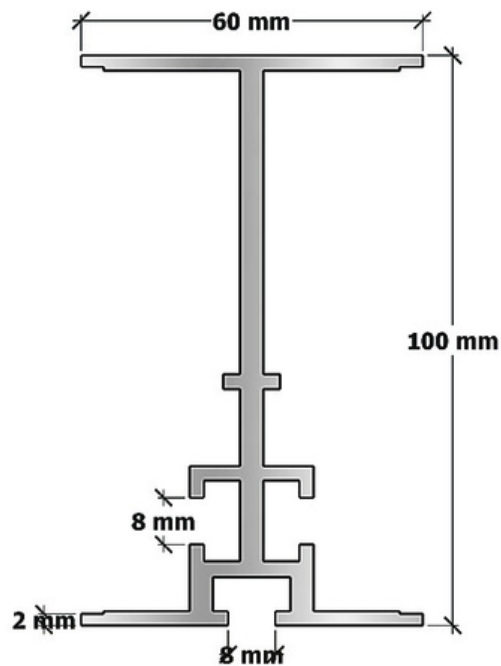
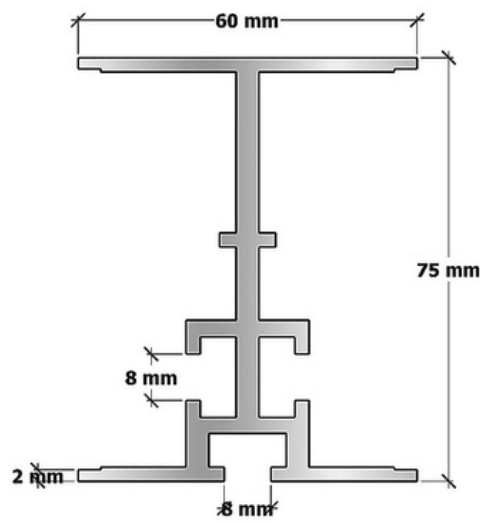
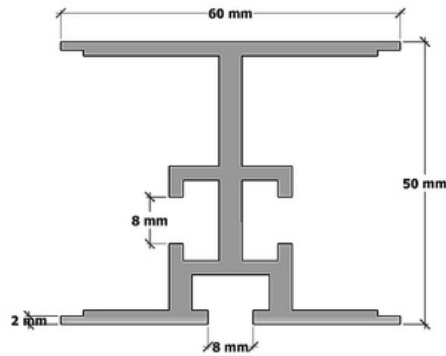



Recommended Pedestal Placement - Box Rail

Wallbarn Aluminium Box Rails/Joists are designed to achieve large spans despite their minimal height and lightweight. These products were independently tested for weight tolerance by Specialist Technical Services (U.K) Limited ([STS- Group](#)).
See the Test Certificate : Appendix C

The testing was conducted in accordance with BS 8579:2020, using the test standard method BS 8527:2020, targeting a load resulting in a 5mm deflection. The recommended spacings provided ensure even distribution of the pedestals along the chosen rail, effectively distributing the weight and reducing point loading.

Rail/Joist Height	Recommended maximum distance between pedestals	STS UK Test - Maximum distance between pedestals
15mm	500mm	600mm
20mm	625mm	800mm
25mm	625mm	1,000mm

15mm Box Rail/Joist

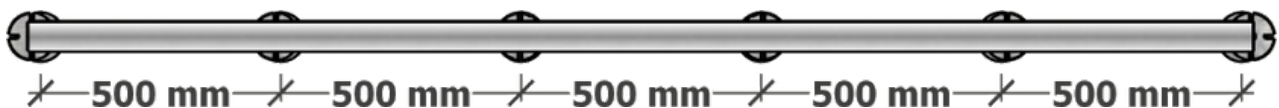

20mm Box Rail/Joist

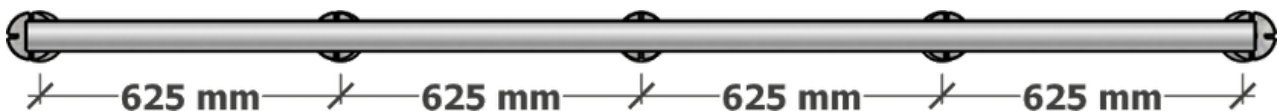

25mm Box Rail/Joist

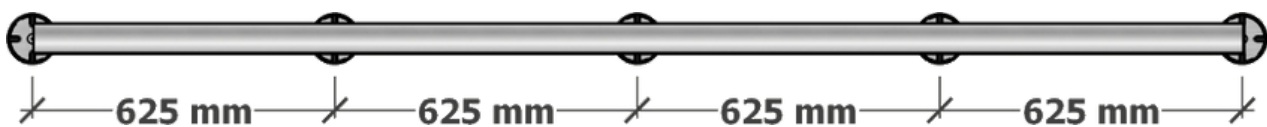



Load Testing - Box Rail

Wallbarn Aluminium Box Rails/Joists have been independently tested by Specialist Technical Services (U.K) Limited to determine destructive load possible. 2 metre lengths of each rail were clamped on each end and a vertical compressive load was applied to the centre. (See Test : Appendix D).

Starting with a 1.05kN force (approximately 107Kg), the rails bent to over 64mm without breaking. It was observed by the tester, that not only did the rails not break under this force but also regained their original shape after test had finished.

Test Product	STS UK Test - Load Obtained (kN)	STS UK Test - Maximum Displacement (mm)
15mm	1.05 (Approx. 107Kg)	68.77
20mm	1.06 (Approx. 108Kg)	65.87
25mm	1.58 (Approx. 161Kg)	64.63

** 1 Kilonewton (kN) is equal to 101.9716213 kilograms

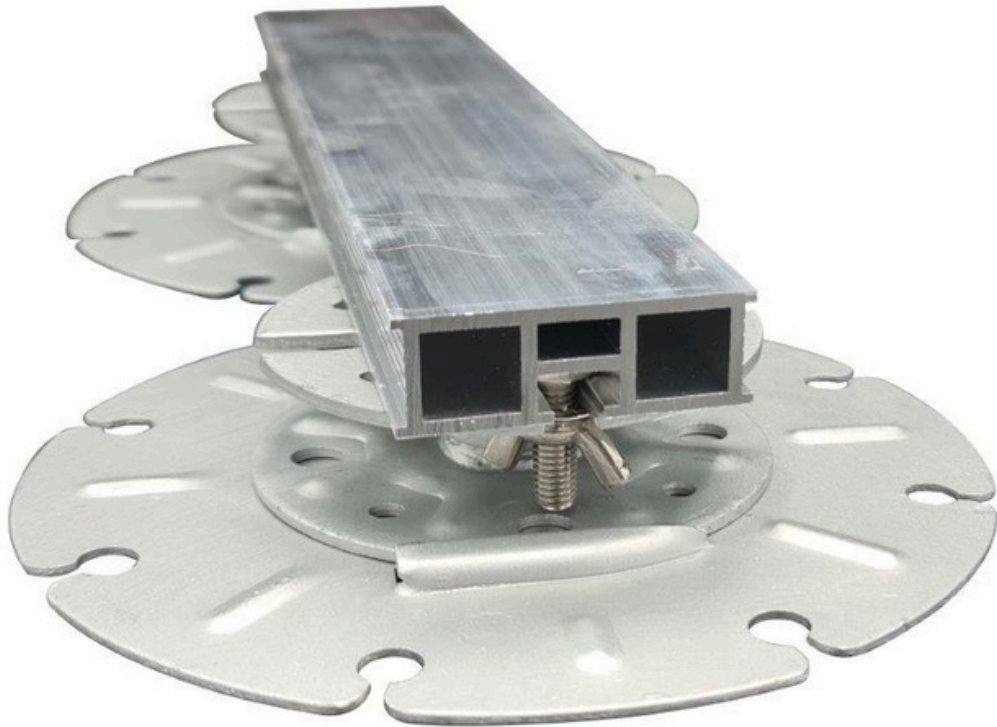

Wallbarn Ltd
Unit 16 Capital Business Centre
22 Carlton Road, South Croydon. CR2 0BS

IMS.T.433.v5

Phone : 0208 916 2222 Email : sales@wallbarn.com Website : www.wallbarn.com



Recommended Pedestal Placement - I-Plus Rail

Wallbarn Aluminium I-Plus Rails/Joists are capable of longer spans. These products were independently tested for weight tolerance by testing organisation, Specialist Technical Services (U.K) Limited. (See Test : Appendix C).

The testing was conducted in accordance with BS 8579:2020, using the test standard method BS 8527:2020, targeting a load resulting in a 5mm deflection. The recommended spacings provided ensure even distribution of the pedestals along the chosen rail, effectively distributing the weight and reducing point loading.

Rail/Joist Height	Recommended maximum distance between pedestals	STS UK Test - Maximum distance between pedestals
50mm	600mm	600mm
75mm	1,200mm	1,200mm
100mm	1,800mm	2,200mm

50mm Box Rail/Joist

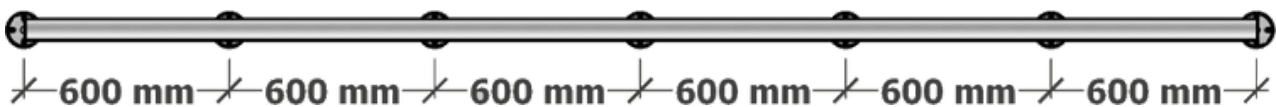

75mm Box Rail/Joist



100mm Box Rail/Joist

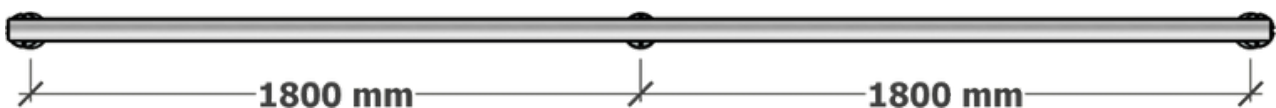



Load Testing - I-Plus Rail

Wallbarn Aluminium I-Plus Rails/Joists have been independently tested by Specialist Technical Services (U.K) Limited to determine destructive load possible. 2 metre lengths of each rail were clamped on each end and a vertical compressive load was applied to the centre. (See Test : Appendix D)

The table below displays the force applied and the corresponding deflection achieved prior to failure.

Test Product	STS UK Test - Load Obtained (kN)	STS UK Test - Maximum Displacement (mm)
50mm	4.08 (Approx. 415Kg)	44.96
75mm	6.58 (Approx. 670Kg)	32.65
100mm	8.10 (Approx. 825Kg)	27.86

** 1 Kilonewton (kN) is equal to 101.9716213 kilograms





PRODUCT INSTALLATION

The Wallbarn Rail System is designed for flat decks and offers versatility for various applications, such as flat roofs, podium decks, balconies, terraces, and walkways. Whether you choose to use it for paving or decking, our aluminium rails/joists are compatible with Wallbarn plastic pedestals and our extensive range of non-combustible pedestals and accessories, ensuring a seamless integration.

For paving applications with the Wallbarn Rail System, we provide plastic and non-combustible headpieces that easily clip or fix onto the rails. The advantage of these components are quickly and easily assembled, making installation hassle-free and efficient.

When using the system for decking applications, it is important to pre-drill the rails/joists before attaching any fixings. To minimize galvanic corrosion, we recommend using high-grade stainless steel fixings. Wallbarn offers various options for both fixings and screws that are suitable for most decking applications. Before installation, it is recommended to store the rails flat and avoid standing them up against a vertical surface, as this could potentially damage the extruded profiles. The best storage method is to place them securely on pallets.

When installing either system onto structural decks, ensure that the surface is strong enough to support the weight of the system. Additionally, it is important to adequately protect waterproofing membranes before installation to prevent point loading or puncturing of the membrane.

INSTALLATION ONTO EXISTING STEEL SUBSTRUCTURE

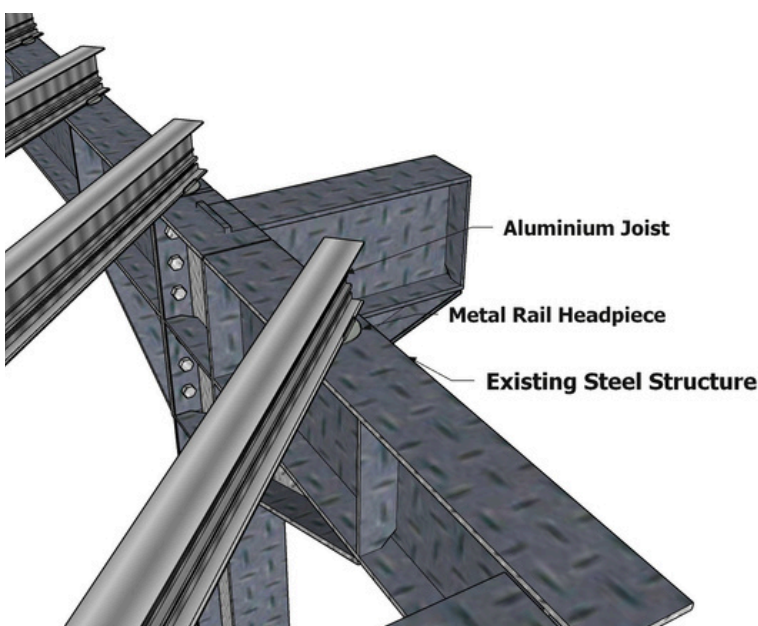

When laying the rails/joists onto existing steel substructure it is recommended to use our [Rail Headpiece](#), which is secured to the substructure at any angle required. This also provides effective barrier protection between the two metals.

Wallbarn further recommends our Class A Tape, to be placed between the rail headpiece and the steel structure. This adds an extra layer and protection against corrosion.

Wallbarn Ltd
Unit 16 Capital Business Centre
22 Carlton Road, South Croydon. CR2 0BS

IMS.T.433.v5

Phone : 0208 916 2222 Email : sales@wallbarn.com Website : www.wallbarn.com



INSTALLATION ONTO EXISTING STEEL SUBSTRUCTURE (cont'd)

Consult the deflection charts provided above when utilizing our aluminium rails/joists on an existing steel structure. It is advisable to avoid spans that would result in a deflection exceeding 5mm for optimal performance.

If using an epoxy-based paint or coating, ensure that it is specifically designed for metal protection and suitable for the intended application. Look for products that have been tested and certified to meet relevant British or European standards, such as those specified for corrosion protection (e.g., BS EN ISO 12944).

INSTALLATION ONTO CONCRETE SURFACE

Consult the deflection charts provided above when using our aluminium rails/joists in conjunction with our pedestals on a concrete subfloor. To ensure optimal performance, we recommend avoiding spans that result in a deflection greater than 5mm.

INSTALLATION ONTO WATERPROOFING MEMBRANE / INSULATION

When using our aluminium rails/joists with pedestals, please refer to the provided load and weight tolerance tests to determine the maximum recommended span for pedestal placement in each specific option.

When installing the system on a waterproof membrane, insulation, or vulnerable subfloors, it is essential to consult with the product manufacturer to ensure their product has the compressive strength to handle the desired spacing of our pedestals. In such cases, we highly recommend using the optional [Spreader Plate](#) with our Class A pedestals to help distribute the weight and reduce point loading. Using the Spreader Plate increases the weight tolerance of the pedestal significantly.

INSTALLATION WITH NON FIRE RATED MEGA-BALANCE PEDESTALS

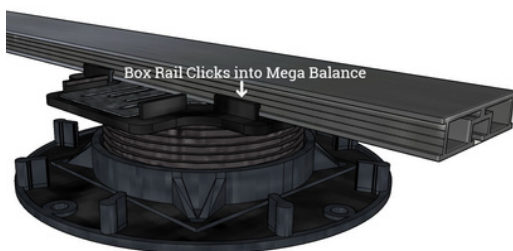

When using aluminium rails/joists with our [Mega-Balance pedestal](#), there is no need for any mechanical fixing. The Mega-Balance pedestal is available with the "Clip" Headpiece, which clips onto all Wallbarn Aluminium Rails

Wallbarn Ltd
Unit 16 Capital Business Centre
22 Carlton Road, South Croydon. CR2 0BS

IMS.T.433.v5

Phone : 0208 916 2222 Email : sales@wallbarn.com Website : www.wallbarn.com

INSTALLATION WITH CLASS A JOIST HOLDERS

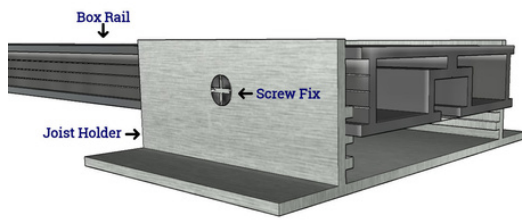

When using with our [Class A Joist Holders](#) to achieve ultra low height thresholds, place the joist/rail onto the inside steps to the height required. They are then secured to the joist holder with one of our stainless steel screws.

INSTALLATION WITH CLASS A METALPAD EX PEDESTALS

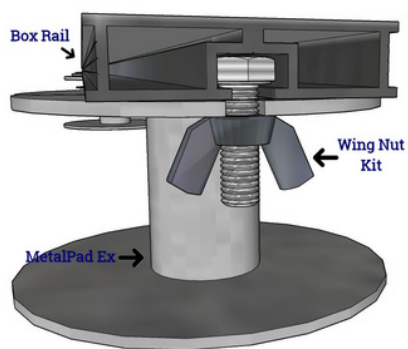

Utilising our [MetalPad Ex Class A Fire Rated Pedestals](#) with the M8 Wing Nut, which can be tightened by hand, offers significant benefits. This approach allows for the initial loose placement of pedestals and joists for precise positioning. Once in place, you can then securely tighten them to establish a stable and robust substructure system.

USING THE RAIL TO RAIL HEADPIECE

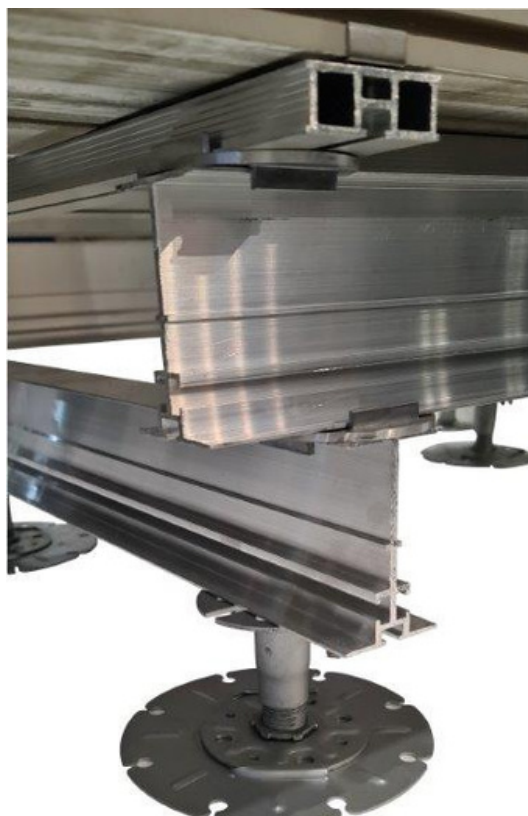

The [Rail to Rail Headpiece](#) is utilised to achieve large height thresholds. It seamlessly fits onto the top surface of any of our aluminium rails, allowing another rail to be stacked perpendicular to the one below.

Designed and manufactured by Wallbarn from high-grade aluminium, this headpiece meets Class A standards, facilitating the creation of a fully non-combustible suspended paving or decking system.





BRACKETS, HEADPIECES & FIXINGS

Box Rail Brackets

To join Box Rails end to end, we offer [stainless steel brackets](#) that are secured with our high grade stainless steel screws.



To join Box Rails at right angles, we offer [stainless steel right angle brackets](#) that are secured with our high grade stainless steel screws.



I-Plus Beam Brackets

To join I-Plus Beams end to end, we designed stainless steel brackets that are secured with our stainless steel [Wing Nut Kits](#).



The same bracket as a right angle is also available to join the rails/joist together at right angles or when you wish to add noggins between rows of joists.





CUTTING AND DRILLING

For cutting rails/joists to length, it is recommended to use premium blades specifically designed to cut metal. This helps minimise sparks and reduces the risk of damaging the extruded profile of each rail/joist. This is especially applicable when working on top of insulation and waterproofing membranes. Also note that damaged profiles may affect their ability to work seamlessly with our pedestals and/or headpieces.

When cutting aluminium, it's important to take certain precautions to ensure safety and achieve accurate cuts. Here are some precautions to consider:

1. Personal Protective Equipment (PPE) : Wear appropriate PPE, including safety glasses or goggles, gloves, and a dust mask or respirator to protect your eyes, hands, and respiratory system from metal shavings and dust.

2. Use the Right Tools : Ensure you have the correct tools for cutting aluminium, such as a mitre saw, circular saw, or a specialized aluminium-cutting saw blade. Using the proper tools will help achieve clean and precise cuts.

3. Secure the Workpiece : Securely clamp the aluminium workpiece to prevent it from moving or vibrating during the cutting process. This will ensure stability and reduce the risk of accidents or inaccurate cuts.

4. Cutting Speed and Pressure : Maintain a steady cutting speed and avoid applying excessive force or pressure. Let the cutting blade do the work and allow it to cut through the aluminium at a controlled pace. Applying too much pressure can lead to rough cuts or blade damage.

5. Clear the Work Area : Prior to cutting any metal, it is important to clear the work area of clutter and unnecessary materials. When metal is being cut, sparks can be generated, so it is crucial to have a clean area free of debris to ensure fire safety. By removing any potential obstructions or hazards, you can create a safer environment during the cutting process.

6. Proper Waste Disposal : Collect and dispose of the aluminium shavings and waste material safely and appropriately. Aluminium shavings can be sharp and therefore has the potential to damage waterproofing membrane and/or insulation.

Always follow the manufacturer's guidelines and safety recommendations specific to the tools and equipment you are using. Additionally, consult local regulations and best practices for safe handling and disposal of aluminium waste.



PRODUCT PERFORMANCE

Wallbarn's Aluminium Box & I-Beam Plus Rail/Joist, if well maintained is extremely long lasting with a product performance Limited Warranty of 15 years with a lifespan of up to 50 years. With care and attention, they can look and perform for many years beyond the warranty period. Please refer to the Limited Warranty details and conditions later in this manual.

Wallbarn aluminium rails/joists are designed to maintain their shape and structural integrity when installed correctly and supported within their specified deflection and point loading limits. To ensure optimal performance, we highly recommend lifting the rails off the sub-deck using our wide range of adjustable pedestals. Our plastic pedestals offer height adjustments ranging from 10mm to 1,025mm, while our steel non-combustible metal pedestals provide adjustments from 25mm to 675mm. For projects that require greater heights in non-combustible settings, you can stack the aluminium rails/joists perpendicular to each other, allowing for even higher elevations. This comprehensive range of pedestals and installation options ensures that you can achieve the desired height and stability for your decking project.

MAINTENANCE DETAILS

The rails/joists used in the system have a relatively low maintenance requirement. In terms of their direct upkeep, there is not much that needs to be done. However, one critical aspect to consider is the proper functioning of the drainage system on the sub-deck where the rails/joists are installed.

It is important to ensure that the area where the rails/joists are placed does not accumulate standing water. If water pools or collects around the rails/joists, it can lead to various issues. Standing water can potentially cause damage to the materials over time, such as rust or corrosion in the case of metallic components. It can also affect the stability and integrity of the overall structure.

To prevent such problems, regular checks and maintenance of the drainage system are necessary. This involves ensuring that the drainage channels or outlets are clear and unobstructed, allowing water to flow away efficiently. Clearing any debris or blockages from the drainage system will help to maintain proper water flow and prevent water from pooling around the rails/joists.

By prioritizing the maintenance of drainage in the area where the rails/joists are installed, you can help ensure the longevity and optimal performance of the system. This proactive approach will minimize the risk of damage or deterioration caused by excessive water exposure and promote a healthier and more stable environment for the rails/joists.

Wallbarn Ltd

IMS.T.433.v5

Unit 16 Capital Business Centre
22 Carlton Road, South Croydon. CR2 0BS

Phone : 0208 916 2222 Email : sales@wallbarn.com Website : www.wallbarn.com



HAZARDS IDENTIFICATION

The major hazards associated with these products are primarily physical, with a focus on manual handling. It is important to note that sparks can be generated during cutting processes.

When working with aluminium, it is recommended to use high-quality saws and drills to minimize the production of particles and sparks. Even though aluminium is relatively easy to cut, using appropriate tools will help reduce the risk of sparks. To ensure safety, it is essential to wear proper protective clothing and equipment when handling and cutting aluminium.

This includes full coverage eye protection, which is particularly important. By utilizing the appropriate safety gear, you can mitigate the potential risks associated with handling and cutting aluminium.

FIRST-AID MEASURES

In case of cuts, it is important to thoroughly wash the wound with ample clean water. Afterward, it is advisable to seek immediate medical attention. Tetanus is a potential concern, so prompt medical evaluation is crucial.

If you experience skin, eye, or respiratory irritation, it is important to seek medical attention as soon as possible. This is especially necessary if you are experiencing any eye irritation.

Prompt medical evaluation will help address any potential issues and ensure appropriate treatment for the symptoms you are experiencing.

FIRE-FIGHTING MEASURES

All of Wallbarn aluminium rails/joists achieve fire resistance Class A1 according to standard BS EN 3501-01 : 2018, so they pose no fire risk.

Therefore, it can be easily installed in public areas and does not constitute a fire hazard. Use extinguishing media appropriate to the surrounding fire conditions.

HAZARD

As supplied, the products are not classified as hazardous.



HANDLING AND STORAGE

When handling aluminium rails/joists, it is essential to consider the risks outlined in the Manual Handling Operations Regulations 1992, and appropriate personal protective equipment (PPE) should be used. The joists will be delivered secured onto pallets, and it is important to utilize suitable lifting equipment operated by qualified personnel when moving the pallets.

To ensure safe storage, the joists should be stored in a stable manner. It is recommended to store them flat and avoid standing them up against a vertical surface, as this can lead to damaging of the profile which may cause issues with fittings and fixtures.

During the cutting process, it is crucial to implement measures to control metal particles and ensure proper ventilation. Additionally, always wear appropriate respiratory and full covered eye protection to safeguard against potential hazards.

DISPOSAL CONSIDERATIONS

Recycling aluminium rails at the end of their life cycle is strongly recommended. Aluminium is a highly recyclable material, and recycling helps conserve resources and reduce environmental impact. By recycling aluminium rails, the material can be processed and used to create new products, reducing the need for virgin aluminium extraction and production.

When it comes to the disposal of aluminium rails, they can be taken to an approved solid waste disposal site. These sites are equipped to handle various types of waste materials, including metals like aluminium. Proper disposal ensures that the rails do not end up in landfills or contribute to environmental pollution.

However, it is important to note that the disposal process should adhere to local or national regulations. Different regions may have specific guidelines and requirements for the disposal of certain materials, including aluminium. These regulations are in place to protect the environment and human health.

To ensure compliance, it is recommended to consult the relevant local or national authorities or waste management agencies for specific guidance on the proper disposal of aluminium rails. They can provide information on designated disposal facilities, recycling programs, or any special instructions that need to be followed.

By following the appropriate local or national regulations for disposal, you can contribute to responsible waste management and help minimize the environmental impact of aluminium rail disposal.



WARRANTIES

A Limited Warranty exists that the products will comply with the test data as laid out in this document for a period of 15 Years. Warranty is limited to replacement of products which have been installed in the correct manner and for the correct purpose only. Warranty is limited to the value of the cost price of the materials only, not replacement costs or any other labour cost.

Under no circumstances shall Wallbarn Ltd be held responsible or liable for any incidental, consequential, indirect, special, punitive or any other damage (including, but not limited to, loss of profits, loss of sales, loss of start-up, loss or reduction of work).

The lifespan of Wallbarn's aluminium rail/joists is expected to be up to 50 Years. This Limited Warranty covers our rails on condition that the Installation and Care & Maintenance Instructions are followed, and our rails/joists are installed according to Wallbarn Ltd guidelines.

See Terms and Conditions of the Warranty and Scope of the Guarantee below for other exclusions and limitations of this Warranty.

1) WARRANTY TERMS AND CONDITIONS

1.1 Complaints are physically examined by Wallbarn Ltd.

1.2 Complaints / claims should be filed in writing to Wallbarn Ltd.

1.3 Proof of purchase of the rails/joists should accompany the written complaint / claim. Complaints / claims without the appropriate documentation will not be considered.

1.4 The company examining complaints (or its representatives) reserves the right to check the rails/joists in the place of installation, the manner they have been installed and obtain details of the care and maintenance programme carried out before giving considering the complaint / claim.

1.7 The complaint / claim is only valid if the products are installed in the territory that the original purchase was made.

1.8 Wallbarn Ltd reserves the right to either repair the defect or to offer material free of charge to the customer.

The above guaranteed lifetime of the Products "aluminium rails/joists" exists only where the Products have been installed in the correct and proper manner.



2) VISUAL APPEARANCE WARRANTY ON DELIVERY

Each aluminium rail/joist is carefully inspected by our quality control team personnel prior to leaving our factory to ensure they are defect free. We urge Customers and the installers to inspect each rail/joist prior to installation. This Limited Warranty does not extend to cover defects in aluminium rail/joists on delivery after installation has taken place.

3) SCOPE OF GUARANTEE

3.1 This guarantee is issued in accordance with and is subject to the laws of England & Wales.

3.2 Obvious defects in the rails/joists should be communicated to the supplier within 30 days from the delivery date of goods on site/warehouse. Claims regarding obvious defects after this period will not be considered.

3.3 To be able to make use of the Warranty the product – aluminium rails/joists - must be installed according to the Installation Instructions. Use fixings recommended and approved by Wallbarn Ltd as indicated in the appropriate technical documentation. The use of other types of fixtures not provided or approved by Wallbarn Ltd invalidates this Warranty.

3.4 If a claim is granted before installing the material, faulty aluminium rails/joists are replaced free of charge.

3.5 No claims can be accepted after installing the material if the buyer could have detected the defects before installation. This Warranty does not cover damage caused by third parties before installation.

TRANSPORT INFORMATION

The best method of transportation is strapped securely onto pallets.



KEY CONTACTS

Wallbarn Ltd.

Unit 16 Capital Business Centre,
22 Carlton Road, South Croydon CR2 0BS

Tel: +44 (0)20 8916 2222

Fax: +44 (0)20 8916 2223

Email: sales@wallbarn.com

Web: www.wallbarn.com

APPENDIX A:

The following table summarizes the documents and URLs referenced in this document:

Product	URL
Aluminium Box Rail	https://www.wallbarn.com/substructure/box-rail/
Aluminium I-Plus Beam	https://www.wallbarn.com/substructure/i-plus-beam/
MetalPad Ex Non-Combustible Pedestals	https://www.wallbarn.com/fire-rated/metalpad-ex/
Fire Rated Products	https://www.wallbarn.com/fire-rated/our-range/
Mega Balance Pedestal	https://www.wallbarn.com/substructure/plastic-pedestal-substructure-system/



LIMITED WARRANTY

Wallbarn Ltd provides a limited warranty of 15 years for products. This Warranty corresponds to the performance and strength characteristics given in the published technical datasheets.

Wallbarn Ltd warrants that, under normal use and service conditions, and where the products have been installed in the proper manner, Wallbarn Ltd products shall be free from material defects in workmanship and materials, shall not crack, splinter, swell, rot or suffer structural damage from damp or fungal decay.

If a defect occurs within the Warranty Period, the Purchaser shall notify Wallbarn Ltd in writing and, after investigation and confirmation of the defect(s) by a Wallbarn Ltd representative, Wallbarn Ltd's sole responsibility shall be limited to replacement of the affected products or to refund the Purchaser up to the maximum value of the Sales Invoice.

This warranty is null and void if:

- The products are not installed in the proper manner as detailed in official Wallbarn Ltd product catalogues, installation guides and technical datasheets.
- The products are not used for the purposes they are intended, as detailed in official Wallbarn Ltd product catalogues, installation guides and technical datasheets.
- Excessive weights, higher than the maximum weight as detailed in official Wallbarn Ltd product catalogues, installation guides and technical datasheets are placed onto the products.
- The products are installed in contravention of any relevant building regulations, code or standards.
- Any relevant building regulations, code or standards, including fire safety regulations are breached on the project during the construction process.
- There is movement, distortion, collapse or settling of the supporting structure on which Wallbarn Ltd products are installed.

Any abnormal natural event such as flooding, hurricane, earthquake, lightning, etc., occurs.



Wallbarn Ltd – Limited Warranty

This limited warranty does not cover any living product or any product which sustains life. This includes sedum and other plants and substrate mixes for M-Tray® and any other green roof system. The living and growing elements of M-Tray® and other green roof systems are specifically excluded from this Warranty.

This Warranty is limited to the maximum amount of the Sales Invoice and Wallbarn Ltd is not liable for any costs of examination, removal or installation of products. Wallbarn Ltd will not be responsible for any costs or expenses incurred during removal and replacement, including labour or transport costs.

This warranty is given only if the products are used for the purposes they are intended, as detailed in official Wallbarn Ltd product catalogues, installation guides and technical datasheets and are installed in the correct manner.

To make a claim under this Limited Warranty, the Purchaser should contact Wallbarn Ltd with a full report of the defects within the Warranty Period, including photographic evidence and proof of purchase. Any claim should be made to sales@wallbarn.com as soon as possible by the Purchaser.

Our Terms & Conditions of Supply can be found here
<https://www.wallbarn.com/terms-conditions-of-supply/>

TEST CERTIFICATE

LOAD TESTING IN ACCORDANCE WITH BS 8579:2020



On Wallbarn Limited,
3 Hagley Court North, The Waterfront, Dudley, West Midlands, DY5 1XF

PROOF LOAD TESTING STS LABORATORY

TEST DESCRIPTION: A weight tolerance test was conducted on various aluminium rails fitted to steel pedestals, increasing in 100mm spans from the centre of the rail. Testing was completed using a jack to apply a vertical compressive load centre to the product, to confirm structural performance. Loading results obtained were recorded at the limit of 5mm deflection. All testing was carried out in accordance with the client's specification.

REF NO.: DR-5744 **DATE TESTED:** 15th May 2024
JOB NO.: P10259 **CERTIFICATE DATE:** 24th May 2024
CERTIFICATE NO.: IC11716 **SUPPLIER/SOURCE:** Client

TEST DETAILS:

Product Tested: Aluminium Rail with Steel Pedestal **Item Condition:** New
Target Loads: 5mm Deflection **Ambient Temperature:** 18°C
Test Location: STS Laboratory **Procedure or Method:** BS 8527:2020

TEST RESULTS:

Test Product	Load Achieved (kN)											
	100mm from Centre	200mm from Centre	300mm from Centre	400mm from Centre	500mm from Centre	600mm from Centre	700mm from Centre	800mm from Centre	900mm from Centre	1000mm from Centre	1100mm from Centre	1200mm from Centre
15mm Rail	2.04	2.08	2.01	1.13								
20mm Rail	2.02		2.03	1.98								
50mm Rail			2.10	1.54	1.43	1.40	1.28					
75mm Rail			2.26	2.03	2.01	1.97	1.90	1.88	1.78	1.28		
100mm Rail			2.02	2.05	2.05	2.05	2.05	2.02	2.00	2.05	2.02	1.90

ANALYSIS:

Testing was completed with each individual rail obtaining various loads before reaching 5mm deflection. The 15mm & 20mm rail reached a 400mm span before the maximum deflection was obtained, with the 100mm rail reaching a span of 1200mm from the centre, before obtaining maximum permissible deflection. All testing was completed within the BS 8572:2020.

For Specialist Technical Services (U.K) Limited			The results found on this Certificate relate only to the product[s] tested as described above This Test Certificate shall <u>not</u> be reproduced except in full QC: TC001 – Test Certificate – v4.0 Page 1 of 1
Approved By:	Andrew Gore		
Position:	Technical Director		
Signature:			

END OF PAGE

TEST CERTIFICATE

LOAD TESTING IN ACCORDANCE WITH THE CLIENT'S SPECIFICATION



On Wallbarn Limited,
3 Hagley Court North, The Waterfront, Dudley, West Midlands, DY5 1XF

PROOF LOAD TESTING STS LABORATORY

TEST DESCRIPTION: A weight tolerance test was conducted on various aluminium rails to determine the destructive load obtainable. Testing was completed using a jack to apply a vertical compressive load centre to the product, to confirm structural performance and determine load failure limit. All testing was carried out in accordance with the client's specification.

REF NO.:	DR-5744	DATE TESTED:	15 th May 2024
JOB NO.:	P10259	CERTIFICATE DATE:	24 th May 2024
CERTIFICATE NO.:	IC11717	SUPPLIER/SOURCE:	Client

TEST DETAILS:			
Product Tested:	Aluminium Rail	Item Condition:	New
Target Loads:	Failure	Ambient Temperature:	18°C
Test Location:	STS Laboratory	Procedure or Method:	Client's Specification

TEST RESULTS:

Test Product	Load Obtained (kN)	Maximum Displacement (mm)
15mm Rail	1.05	68.77
20mm Rail	1.06	65.87
25mm Rail	1.58	64.63
50mm Rail	4.08	44.96
75mm Rail	6.58	32.65
100mm Rail	8.10	27.86

ANALYSIS:

Testing was completed with each individual rail obtaining various loads before reaching failure. The 15mm rail obtained the lowest load (1.05kN) along with the highest displacement (68.77mm), with the 100mm obtaining the highest loading (8.10kN) along with the lowest recorded displacement (27.86mm). All testing was completed within the client's specification.

For Specialist Technical Services (U.K) Limited			<p>The results found on this Certificate relate only to the product[s] tested as described above This Test Certificate shall <u>not</u> be reproduced except in full</p> <p>QC: TC001 – Test Certificate – v4.0 Page 1 of 1</p>
Approved By:	Andrew Gore		
Position:	Technical Director		
Signature:			

END OF PAGE

Unit D4, Poole Hall Business Park, Poole Hall Road, Ellesmere Port, Cheshire, CH66 1UA, United Kingdom

T: +44 (0) 1244 794 104 F: +44 (0) 1244 794 204

E: Info@sts-group.co.uk

Offices Located at: Chester | Ellesmere Port

Website: <https://www.sts-group.co.uk>

