

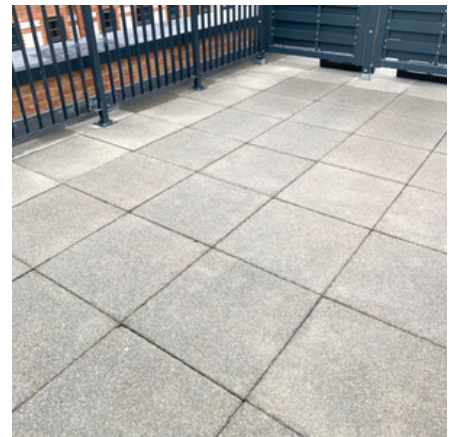

# Operations & Maintenance Manual

## Fire Rated Rail System

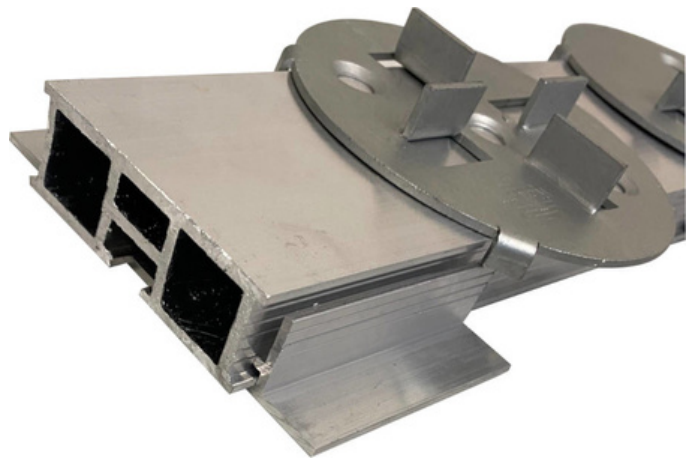
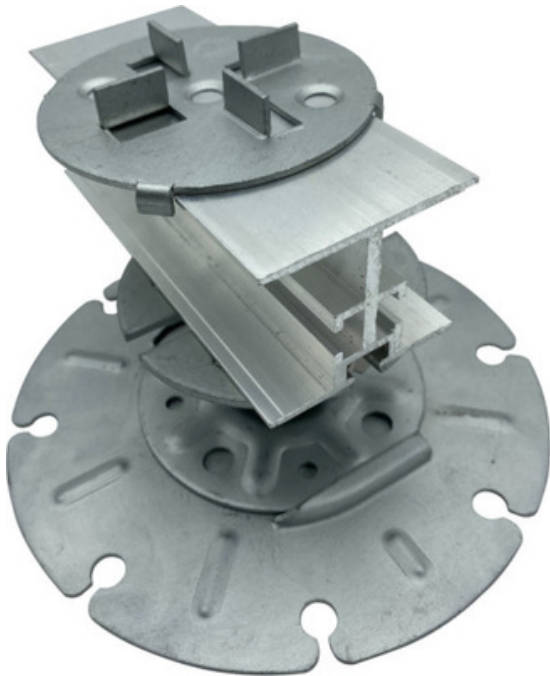

Wallbarn Ltd  
Unit 16 Capital Business Centre  
22 Carlton Road, South Croydon. CR2 0BS

IMS.T.1092.v2

Phone : 020 8916 2222 Email : [sales@wallbarn.com](mailto:sales@wallbarn.com) Website : [www.wallbarn.com](http://www.wallbarn.com)



## PRODUCT DESCRIPTION

The Fire-Rated Rail System is designed for paving and decking projects that are specified as Class A. This is typically for terraces, balconies and flat roofs on buildings of 18m in height.

### Enhanced Support and Stability

This Class A integrated rail system for installing fire-rated decking, porcelain tiles or paving slabs offers enhanced support and lateral strength across the deck. The all metal substructure securely links the pedestals, improving overall surface stability.

### Compatibility and Versatility

The modular design pairs with any Wallbarn aluminium rail, including Box Rails and I-Plus Rails, and is fully compatible with our [MetalPad Ex](#) and [Joist Holder](#) pedestals.

### Headpiece for Paving Projects

For paving installations, the system includes a headpiece that clips onto the aluminium rail. This headpiece features integrated lugs that securely hold porcelain or other tiles and slabs in place while providing necessary gaps for drainage. The adjustable headpiece slides along the rail to ensure a precise fit at tile edges. Lugs are 2mm in width and 10mm high.

### Efficient and Lightweight Design

Ideal for 20mm porcelain tiles/planks or concrete slabs/flags, the system requires no mechanical fixings. The aluminium rail is secured to the pedestal with an M8 Wing Nut Kit, and the headpiece clips onto the rail, significantly reducing installation time. Lightweight components, including the rails and joists, make handling on-site easier and safer.

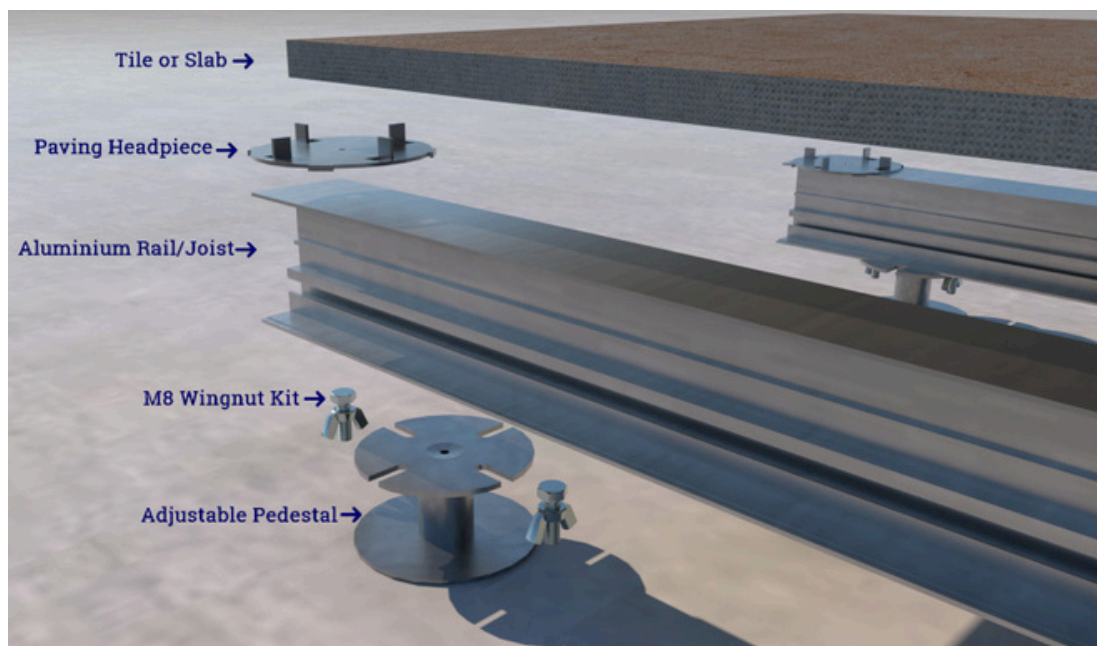

Wallbarn Ltd

IMS.T.1092.v2

Unit 16 Capital Business Centre  
22 Carlton Road, South Croydon. CR2 0BS

Phone : 020 8916 2222 Email : [sales@wallbarn.com](mailto:sales@wallbarn.com) Website : [www.wallbarn.com](http://www.wallbarn.com)



## SYSTEM COMPONENTS

### MetalPad Ex Adjustable Pedestals

Non-combustible, fully adjustable, Class A pedestal specially designed for suspended decking and paving systems on exterior high-rise balconies, terraces and flat roofs.

The pedestals are covered in Zintec 200 anti corrosion protective coating. This makes the pedestals suitable for external applications and also creates a barrier between the steel and the aluminium.

- There are zero plastic or rubber components ensuring it's Class A rating.
- Rated Class A according to BS EN 13501-1:2018 and EC Decision 94/61 1/EC.
- Independently weight tested by STS UK to 49.86kN (Approximately 5,080Kg) - ([Go to Report](#))
- Independently Fire Tested by Warrington Fire to meet Class A fire rating. ([Go to Report](#)).

They are covered in Zintec 200 coating provides a superior finish, which offers outstanding cathodic corrosion protection and staves off white rust formation. Zintec 200 also demonstrates exceptional performance in Neutral Salt Spray Testing (NSST) as well as in Cyclic Corrosion Testing (CCT).- ([Go to Technical Document for Zintec 200](#)).

Accurate levelling of the floor surface is possible with millimetre precision by twisting the threaded stem to adjust the height. The height can be adjusted even with the paving slab or rail / decking system in place by simply turning the stem. The headpiece is 95mm diameter and the circular baseplate is 100mm in diameter.

The MetalPad Ex has been designed to work with a number of accessories, headpieces and Wallbarn Aluminium Joists/Rails to create substructure for paving or decking projects that need to meet the latest rules related to Class A specified projects.



## Physical & Chemical Properties

<b>MATERIAL</b>	Mild Steel	EN 10152
<b>PEDESTAL COATING</b>	Zintec 200 corrosion protection coating	
<b>THREADED STEM</b>	Mild Steel Class 4:8	
<b>FIRE CLASSIFICATION</b>	Class A - EC Decision 96/603/EC   BS EN 13501-1:2018	
<b>BUILDING STANDARDS COMPLIANCE</b>	Approved Document B (amended)	2022
	British Standard (balcony construction)	BS 8579
<b>USE/PURPOSE</b>	Suspended decking and paving projects on Balconies, Terraces, Flat Roof & Podium Decks.	
<b>WEIGHT TOLERANCE</b>	49.86kN (Approximately 5,080Kg) per unit	
<b>WEIGHT TOLERANCE WITH SPREADER PLATE</b>	70.69kN (Approximately 7,207Kg) per unit	
<b>DURABILITY</b>	MetalPad EX is manufactured for long-term performance and resistance to corrosion, exposure to elements and to UV rays	
<b>WARRANTY</b>	Limited warranty 15 years	
	Life span 50 years	
<b>TOXICITY</b>	These products are not classified as toxic	
<b>HEADPIECE</b>	95mm diameter with central hole 6mm diameter 4 x connection slots 10mm x 22mm	
<b>BASE PLATE</b>	100mm diameter Circular Base plate 4 x drilled drainage holes 10mm diameter 4 x drilled fixing holes 6mm diameter	



## MetalPad Ex Heights

The MetalPad Ex system is Class A rated (EN 13501-1:2018) and fully compliant with BS 8579, offering a massive height range with the flexibility for multiple rail build-ups. Each pedestal supports over 5 tonnes, resists rotting, warping, and rusting, and includes all necessary fixings and connectors. The pedestal base is 100mm in diameter, expandable to 185mm with an optional spreader plate for vulnerable sub-floors, while the 95mm head accommodates various applications.



**26-35mm**

SP-MET-EX-026-Z



**30-40mm**

SP-MET-EX-030-Z



**40-50mm**

SP-MET-EX-040-Z



**50-70mm**

SP-MET-EX-050-Z



**60-90mm**

SP-MET-EX-060-Z



**75-115mm**

SP-MET-EX-075-Z



**110-185mm**

SP-MET-EX-110-Z



**185-260mm**

SP-MET-EX-185-Z



**250-325mm**

SP-MET-EX-250-Z



**300-375mm**

SP-MET-EX-300-Z

(Larger height pedestals above 375mm are available on special order)

Wallbarn Ltd  
Unit 16 Capital Business Centre  
22 Carlton Road, South Croydon. CR2 0BS

IMS.T.1092.v2

Phone : 020 8916 2222 Email : [sales@wallbarn.com](mailto:sales@wallbarn.com) Website : [www.wallbarn.com](http://www.wallbarn.com)



## SYSTEM COMPONENTS

### Class A Ultra Low Rail Holders

Wallbarn Class A1 Aluminium Ultra Low Rail Holders are made from high-grade extruded aluminium. Designed by Wallbarn and manufactured in the United Kingdom, they are suited to both paving and decking applications when used with applicable headpieces.

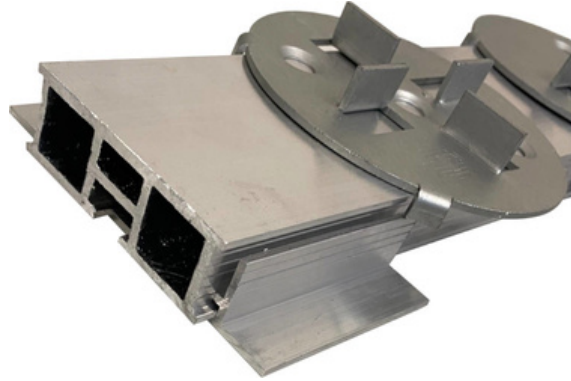

### Physical & Chemical Properties

	17mm Ultra Low Rail Holder	27mm Ultra Low Rail Holder
<b>Profile</b>		
<b>Material</b>	Aluminium 6063 T6	Aluminium 6063 T6
<b>Weight</b>	0.074kgs	0.081gs
<b>Height</b>	17mm	27mm
<b>Width</b>	93mm	93mm
<b>Length</b>	60mm	60mm
<b>Fire Classification</b>	Class A1 BS EN 13501-1 2018	







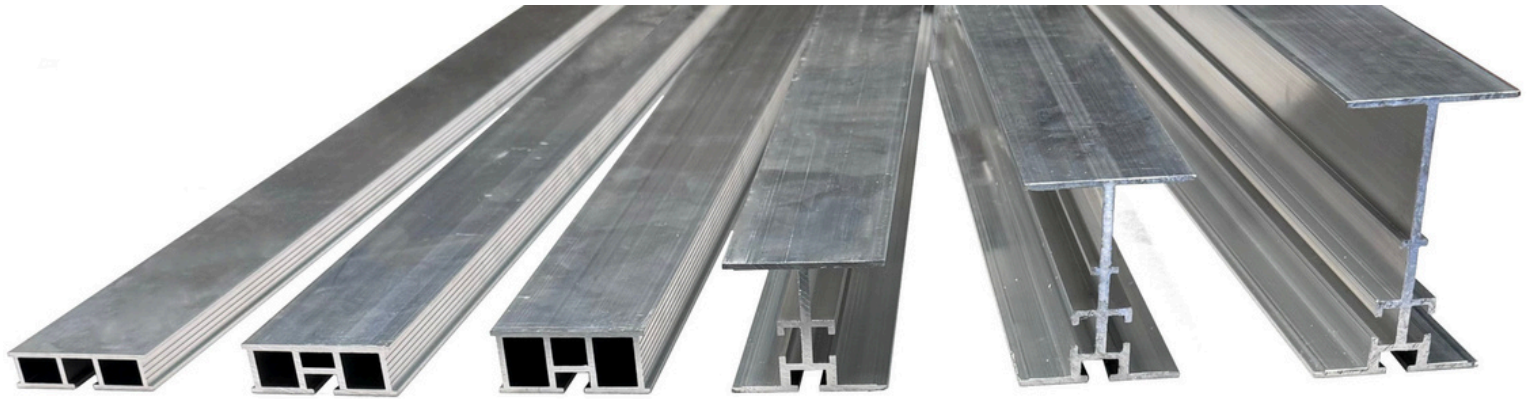

## SYSTEM COMPONENTS

### Box Rail & I-Plus Rail

Wallbarn Aluminium Rails/Joists, made from high-grade 6063 T6 extruded aluminium, are designed and manufactured in the UK for heavy-duty paving and decking applications. Specifically designed to seamlessly connect with Wallbarn's Mega Balance and MiniPad pedestals, they provide secure installation without the need for mechanical fixings.

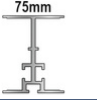

## PHYSICAL & CHEMICAL PROPERTIES

	15mm Box Rail	20mm Box Rail	25mm Box Rail	50mm I-Plus Beam	75mm I-Plus Beam	100mm I-Plus Beam
Profile						
Material	<b>ALUMINIUM 6063 T6</b>					
Fire Classification	<b>Class A1 BS EN 13501-1 2018</b>					
Weight	0.90kg/m	0.99kg/m	1.99kg/m	1.61kg/m	1.92kg/m	2.19kg/m
Height	15mm	20mm	25mm	50mm	75mm	100mm
Length	2,400mm	2,400mm	2,400mm	3,600mm	3,600mm	3,600mm

Wallbarn Ltd  
Unit 16 Capital Business Centre  
22 Carlton Road, South Croydon. CR2 0BS

IMS.T.1092.v2

Phone : 020 8916 2222 Email : [sales@wallbarn.com](mailto:sales@wallbarn.com) Website : [www.wallbarn.com](http://www.wallbarn.com)

## SYSTEM COMPONENTS

### Box Rail & I-Plus Rail

Wallbarn Aluminium Rails/Joists, made from high-grade 6063 T6 extruded aluminium, are designed and manufactured in the UK for heavy-duty paving and decking applications. Specifically designed to seamlessly connect with Wallbarn's Mega Balance and MiniPad pedestals, they provide secure installation without the need for mechanical fixings.

#### Box Rail Profiles

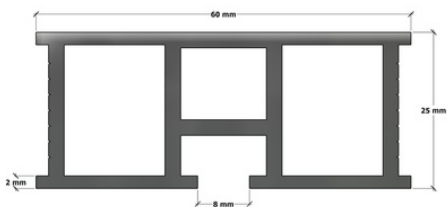
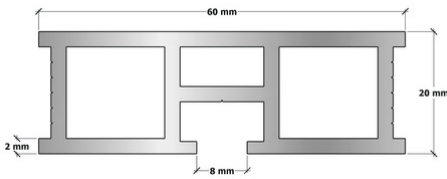
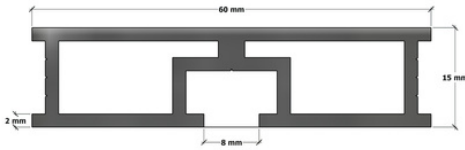

#### I-Plus Beam Profiles

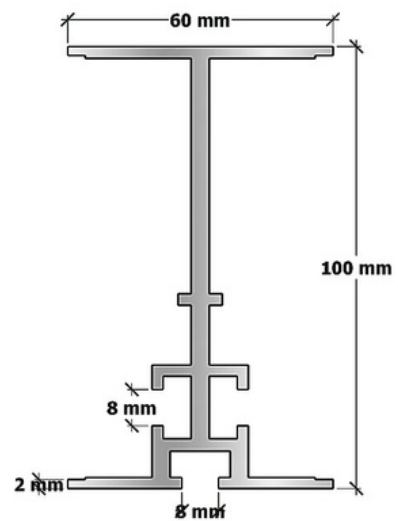
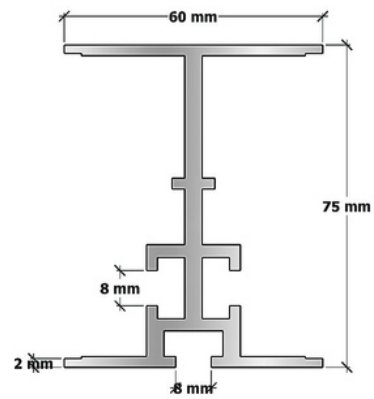
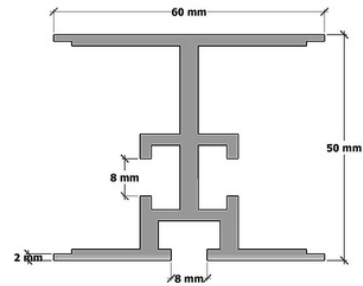





## Recommended Pedestal Placement - Box Rail

Wallbarn Aluminium Box Rails/Joists are designed to achieve large spans despite their minimal height and lightweight. These products were independently tested for weight tolerance by Specialist Technical Services (U.K) Limited ([STS- Group](#)). See the Test Certificate : [Appendix D](#)

The testing was conducted in accordance with BS 8579:2020, using the test standard method BS 8527:2020, targeting a load resulting in a 5mm deflection. The recommended spacings provided ensure even distribution of the pedestals along the chosen rail, effectively distributing the weight and reducing point loading.

Rail/Joist Height	Recommended maximum distance between pedestals	STS UK Test - Maximum distance between pedestals
15mm	600mm	600mm
20mm	600mm	600mm
25mm	800mm	800mm

### 15mm Box Rail/Joist

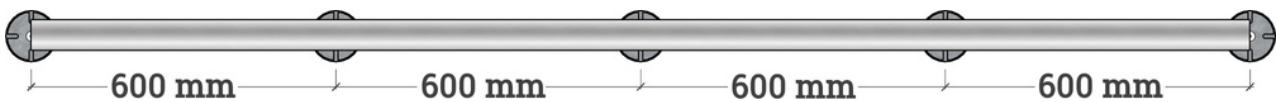

### 20mm Box Rail/Joist

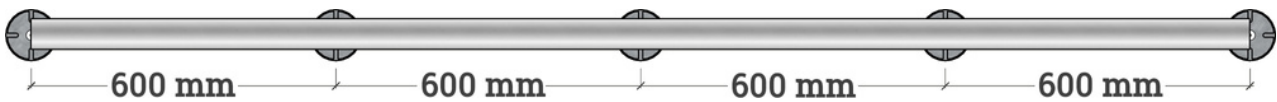

### 25mm Box Rail/Joist

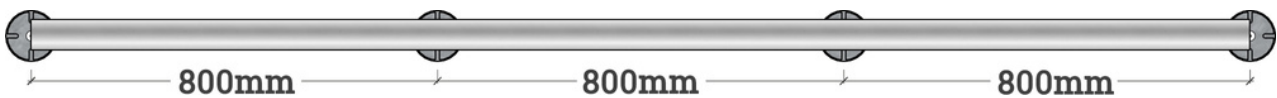



## Load Testing - Box Rail

Wallbarn Aluminium Box Rails/Joists have been independently tested by Specialist Technical Services (U.K) Limited to determine destructive load possible. The lengths of each rail were clamped on each end and a vertical compressive load was applied to the centre. ([See Test : Appendix E](#))

Starting with a 1.05kN force (approximately 107Kg), the 15mm & 20mm Box Rails bent to over 64mm without breaking. It was observed by the tester, that not only did the rails not break under this force but also regained their original shape after test had finished.

Test Product	STS UK Test - Load Obtained (kN)	STS UK Test - Maximum Displacement (mm)
15mm	1.05 (Approx. 107Kg)	68.77
20mm	1.06 (Approx. 108Kg)	65.87
*25mm	5.14 (Approx. 524Kg)	62.66

**1 Kilonewton (kN) is approximately equal to 101.9716213 kilograms**

\*The 25mm Box Rail was redesigned in late 2024 making it much stronger than it's predecessor. Refer to the test done on the earlier version in [Appendix E](#) versus the current version in [Appendix H](#)

### Appendix E Snapshot

25mm Rail	1.58	64.63
-----------	------	-------

### Appendix H Snapshot

Test Product	Load Achieved (kN)	Displacement (mm)
25mm rail	5.14	62.66

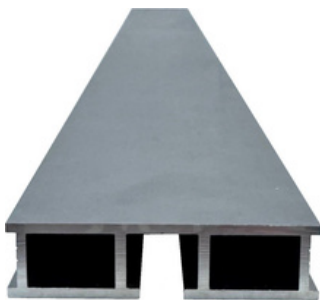

15mm Box Rail



20mm Box Rail



25mm Box Rail



## Recommended Pedestal Placement - I-Plus Rail

Wallbarn Aluminium I-Plus Rails/Joists are capable of longer spans. These products were independently tested for weight tolerance by testing organisation, Specialist Technical Services (U.K) Limited. ([See Test : Appendix D](#))

The testing was conducted in accordance with BS 8579:2020, using the test standard method BS 8527:2020, targeting a load resulting in a 5mm deflection. The recommended spacings provided ensure even distribution of the pedestals along the chosen rail, effectively distributing the weight and reducing point loading.

Rail/Joist Height	Recommended maximum distance between pedestals	STS UK Test - Maximum distance between pedestals
50mm	600mm	600mm
75mm	900mm	1,000mm
100mm	1,800mm	2,200mm

### 50mm I-Plus Rail/Joist

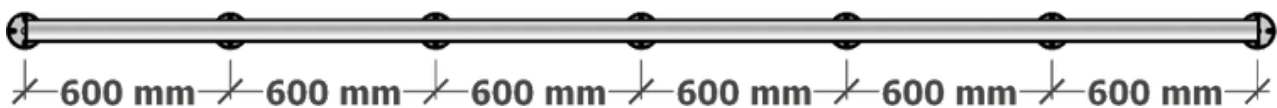

### 75mm I-Plus Rail/Joist

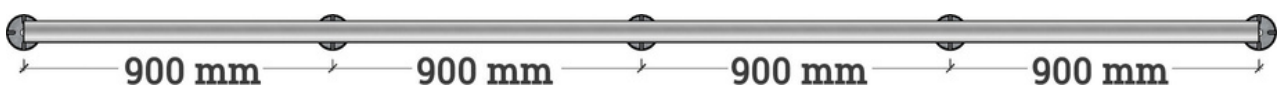

### 100mm I-Plus Rail/Joist

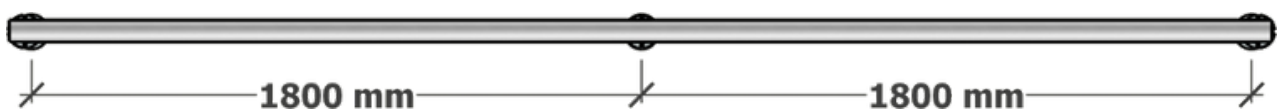



## Load Testing - I-Plus Rail

Wallbarn Aluminium I-Plus Rails/Joists have been independently tested by Specialist Technical Services (U.K) Limited to determine destructive load possible. 2 metre lengths of each rail were clamped on each end and a vertical compressive load was applied to the centre. (See Test : Appendix E)

The table below displays the force applied and the corresponding deflection achieved prior to failure.

Test Product	STS UK Test - Load Obtained (kN)	STS UK Test - Maximum Displacement (mm)
50mm	4.08 (Approx. 415Kg)	44.96
75mm	6.58 (Approx. 670Kg)	32.65
100mm	8.10 (Approx. 825Kg)	27.86

1 Kilonewton (kN) is approximately equal to 101.9716213 kilograms

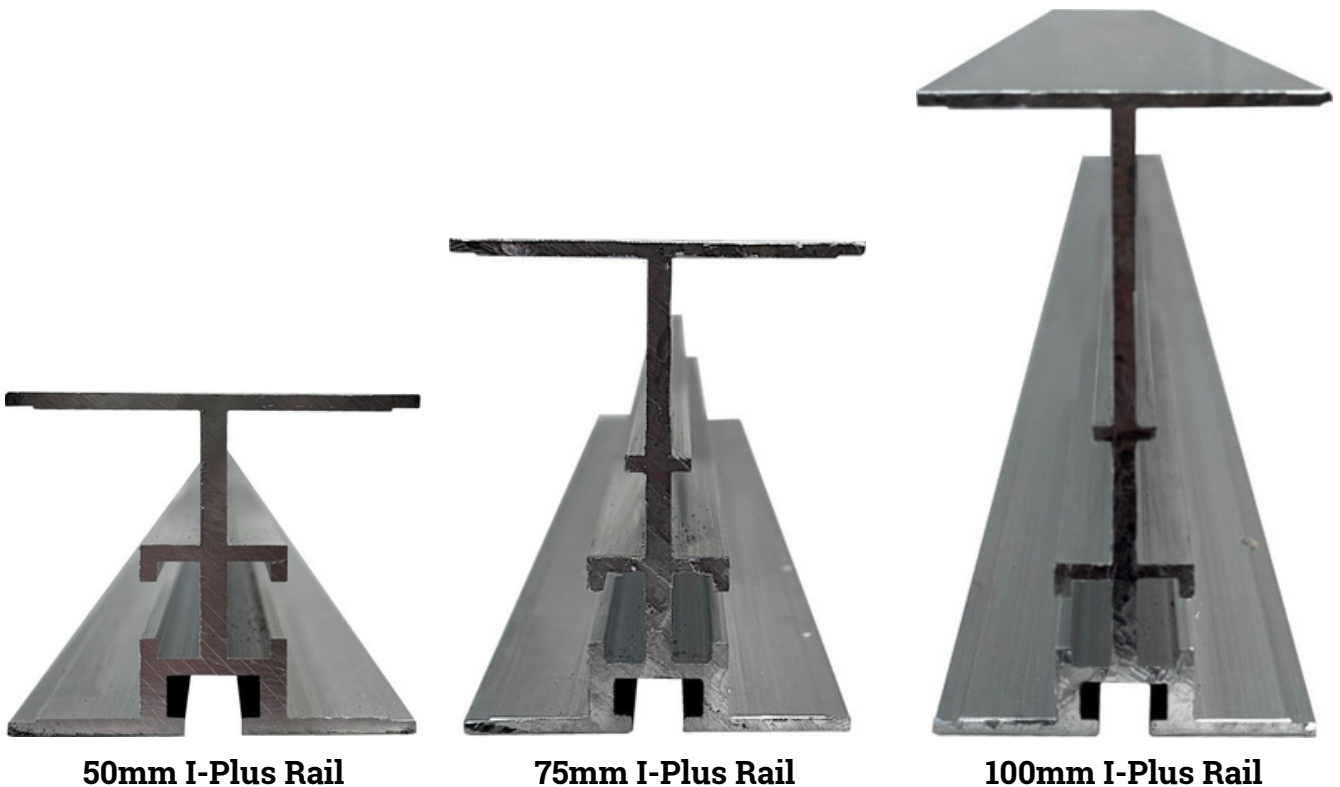



## Increasing Structural Integrity through Noggins

The use of noggins as part of Wallbarn's aluminium Box Rail and I-Plus Rail systems, significantly adds to their structural integrity and load-bearing capacity. By incorporating noggins at regular intervals, the rails have increased lateral stability and resistance to deflection under load. This added reinforcement is particularly important in applications where wider pedestal support spacings are required, ensuring a reliable decking or paving solution.

Independent testing has demonstrated the dramatic improvement achieved through the use of noggins, increasing the strength & stability by up to 40%.

### Analysis One : 75mm I-Plus Rail

The 75mm I-Plus Rail, when tested as a single rail, supported a load of approximately 1.94kN at a 5mm deflection with a span of 1,300mm ([See Appendix D](#)).

When noggins were added between two 75mm I-Plus Rails at the same span, the load capacity increased significantly, recording 2.75kN at a 5mm deflection. This is an increase in strength of 41.75% ([See Appendix F](#))

#### Appendix D Snapshot

TEST RESULTS:

Test Product	Load Achieved (kN)											
	100mm from Centre	200mm from Centre	300mm from Centre	400mm from Centre	500mm from Centre	600mm from Centre	700mm from Centre	800mm from Centre	900mm from Centre	1000mm from Centre	1100mm from Centre	1200mm from Centre
15mm Rail	2.04	2.08	2.01	1.13								
20mm Rail	2.02		2.03	1.98								
50mm Rail			2.10	1.54	1.43	1.40	1.28					
75mm Rail			2.26	2.03	2.01	1.97	1.90	1.88	1.78	1.28		
100mm Rail			2.02	2.05	2.05	2.05	2.05	2.02	2.00	2.05	2.02	1.90



#### Appendix F Snapshot

TEST RESULTS:

Product	Bearing Span (mm)	Load Achieved at 5mm Deflection (kN)
75mm Rail	1300	2.75

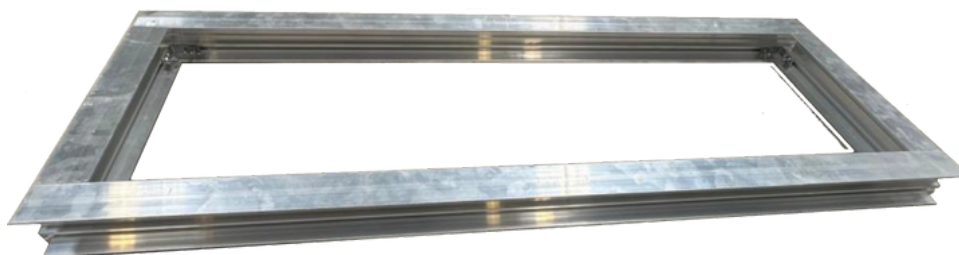

## Increasing Structural Integrity through Noggins cont'd

### Analysis Two : 100mm I-Plus Rail

The 100mm I-Plus Rail, when tested as a single rail, supported a load of 2.02kN at a 5mm deflection with a pedestal spacing of 2,200mm ([See Appendix D](#)).

Tested with the addition of noggins spaced at 1200mm intervals, with a greatly increased pedestal spacing of 3,100mm, the test recorded a load of 2.07kN to a 5mm deflection ([See Appendix G](#)).

This demonstrates the substantial improvement in structural performance provided by noggins, allowing for greater flexibility in design while maintaining strength and safety.

#### Appendix D Snapshot

TEST RESULTS:

Test Product	Load Achieved (kN)											
	100mm from Centre	200mm from Centre	300mm from Centre	400mm from Centre	500mm from Centre	600mm from Centre	700mm from Centre	800mm from Centre	900mm from Centre	1000mm from Centre	1100mm from Centre	1200mm from Centre
15mm Rail	2.04	2.08	2.01	1.13								
20mm Rail	2.02		2.03	1.98								
50mm Rail			2.10	1.54	1.43	1.40	1.28					
75mm Rail			2.26	2.03	2.01	1.97	1.90	1.88	1.78	1.28		
100mm Rail			2.02	2.05	2.05	2.05	2.05	2.02	2.00	2.05	2.02	1.90



#### Appendix G Snapshot

TEST RESULTS:

Tests	Load (kN) at 2700mm	Load (kN) at 3100mm	Classification
1	2.69	2.07	Pass

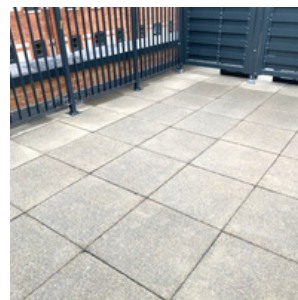



## BRACKETS, HEADPIECES & FIXINGS

### Box Rail Brackets

To join Box Rails end to end, we offer [stainless steel brackets](#) that are secured with our high grade stainless steel screws.



To join Box Rails at right angles, we offer [stainless steel right angle brackets](#) that are secured with our high grade stainless steel screws.





## I-Plus Beam Brackets

To join I-Plus Beams end to end, we designed stainless steel brackets that are secured with our stainless steel [Wing Nut Kits](#).



The same bracket as a right angle is also available to join the rails/joist together at right angles or when you wish to add noggins between rows of joists.







## SYSTEM COMPONENTS

### Rail Headpiece (for paving projects)

The Rail Headpieces fit directly onto aluminium rails without the need for mechanical fixing. The lugged design securely holds tiles or slabs while creating a drainage gap between them. Made of galvanised steel and coated with Zintec 200 for corrosion resistance, these Class A fire-rated headpieces are available in various lug configurations, accommodating layouts such as brickwork or stretcher bond

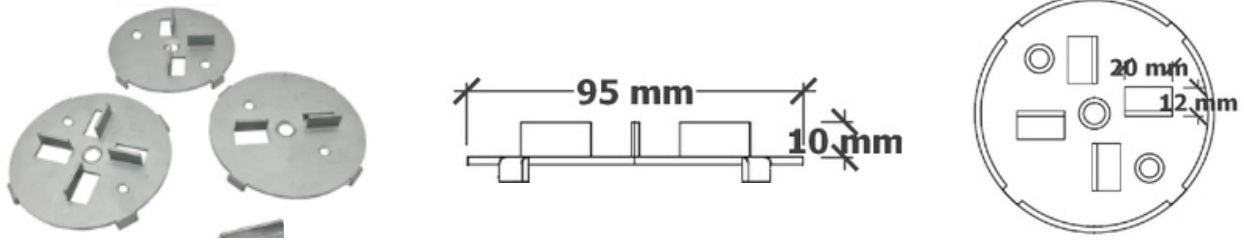

### Physical & Chemical Properties

<b>MATERIAL</b>	Mild Steel	EN 10152
<b>PEDESTAL COATING</b>	Zintec 200 corrosion protection coating	
<b>THREADED STEM</b>	Mild Steel Class 4:8	
<b>FIRE CLASSIFICATION</b>	Class A - EC Decision 96/603/EC   BS EN 13501-1:2018	
<b>BUILDING STANDARDS COMPLIANCE</b>	Approved Document B (amended)	2022
	British Standard (balcony construction)	BS 8579
<b>USE/PURPOSE</b>	Suspended paving projects on Balconies, Terraces & Flat Roofs	
<b>DURABILITY</b>	Headpiece is manufactured for long-term performance and resistance to corrosion, exposure to elements and to UV rays	
<b>WARRANTY</b>	Limited warranty 15 years	
	Life span 50 years	
<b>TOXICITY</b>	These products are not classified as toxic	



## SYSTEM COMPONENTS

### Optional Spreader Plate

The Spreader Plate, when used with our compatible Class A Pedestals, is designed to disperse weight and reduce point loading on delicate subfloors, such as insulation or waterproof membranes ([See Report](#)).

The Spreader Plate is compatible with our [MetalPad Ex Pedestal](#) and [Class A Joist Holder](#), offering versatile support without the need for mechanical fixing. Made from galvanised steel with a Zintec 200 coating, it resists rust and corrosion and meets Class A fire rating standards. The 185mm diameter plate features a smooth underside, effectively distributing weight and significantly increasing the pedestal's weight tolerance when used on softer surfaces.

### PHYSICAL AND CHEMICAL PROPERTIES

<b>MATERIAL</b>	Mild Steel	EN 10152
<b>COATING</b>	Zintec 200 corrosion protection coating	
<b>FIRE CLASSIFICATION</b>	Class A1 - EC Decision 96/603/EC   BS EN 13501-1:2018	
<b>BUILDING STANDARDS COMPLIANCE</b>	Approved Document B (amended)	2022
	British Standard (balcony construction)	BS 8579
<b>DURABILITY</b>	The Spreader Plate is manufactured for long-term performance and resistance to corrosion, exposure to elements and to UV rays	
<b>WARRANTY</b>	Limited warranty 15 years	
	Life span 50 years	
<b>TOXICITY</b>	These products are not classified as toxic	

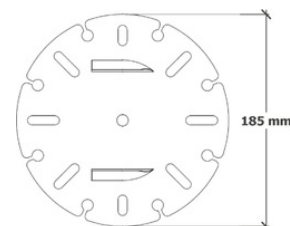

Wallbarn Ltd  
 Unit 16 Capital Business Centre  
 22 Carlton Road, South Croydon. CR2 0BS

IMS.T.1092.v2

Phone : 020 8916 2222 Email : [sales@wallbarn.com](mailto:sales@wallbarn.com) Website : [www.wallbarn.com](http://www.wallbarn.com)



## **PRODUCT INSTALLATION**

The Wallbarn Rail System is designed for flat decks and offers versatility for various applications, such as flat roofs, podium decks, balconies, terraces, and walkways. Whether you choose to use it for paving or decking, our aluminium rails/joists are compatible with Wallbarn plastic pedestals and our extensive range of non-combustible pedestals and accessories, ensuring a seamless integration.

For paving applications with the Wallbarn Rail System, we provide plastic and non-combustible headpieces that easily clip or fix onto the rails. The advantage of these components are quickly and easily assembled, making installation hassle-free and efficient.

When using the system for decking applications, it is important to pre-drill the rails/joists before attaching any fixings. To minimize galvanic corrosion, we recommend using high-grade stainless steel fixings. Wallbarn offers various options for both fixings and screws that are suitable for most decking applications. Before installation, it is recommended to store the rails flat and avoid standing them up against a vertical surface, as this could potentially damage the extruded profiles. The best storage method is to place them securely on pallets.

When installing either system onto structural decks, ensure that the surface is strong enough to support the weight of the system. Additionally, it is important to adequately protect waterproofing membranes before installation to prevent point loading or puncturing of the membrane.

## **INSTALLATION ONTO WATERPROOFING MEMBRANE / INSULATION**

When using our aluminium rails/joists with pedestals, please refer to the provided load and weight tolerance tests to determine the maximum recommended span for pedestal placement in each specific option.

When installing the system on a waterproof membrane, insulation, or vulnerable subfloors, it is essential to consult with the product manufacturer to ensure their product has the compressive strength to handle the desired spacing of our pedestals. In such cases, we highly recommend using the optional [Spreader Plate](#) with our Class A pedestals to help distribute the weight and reduce point loading. Using the Spreader Plate increases the weight tolerance of the pedestal significantly.



## **PRODUCT PERFORMANCE**

Wallbarn's Rail System, if well maintained is extremely long lasting with a product performance Limited Warranty of 15 years with a lifespan of up to 30 years. With care and attention, they can look and perform for many years beyond the warranty period. Please refer to the Limited Warranty details and conditions later in this manual.

The system is designed to maintain their shape and structural integrity when installed correctly and supported within their specified deflection and point loading limits. To ensure optimal performance, we highly recommend lifting the rails off the sub-deck using our wide range of adjustable pedestals. Our plastic pedestals offer height adjustments ranging from 10mm to 1,025mm. For projects that require greater heights in non-combustible settings, you can stack the aluminium rails/joists perpendicular to each other, allowing for even higher elevations. This comprehensive range of pedestals and installation options ensures that you can achieve the desired height and stability for your decking project.

## **MAINTENANCE DETAILS**

The system has a relatively low maintenance requirement. In terms of their direct upkeep, there is not much that needs to be done. However, one critical aspect to consider is the proper functioning of the drainage system on the sub-deck where the rails/joists are installed.

It is important to ensure that the area where the pedestals are placed does not accumulate standing water. If water pools or collects around the pedestals, it can lead to various issues. Standing water can potentially cause damage to the materials over time. It can also affect the stability and integrity of the overall structure.

To prevent such problems, regular checks and maintenance of the drainage system are necessary. This involves ensuring that the drainage channels or outlets are clear and unobstructed, allowing water to flow away efficiently. Clearing any debris or blockages from the drainage system will help to maintain proper water flow and prevent water from pooling around the rails/joists.

By prioritizing the maintenance of drainage in the area where the rails/joists are installed, you can help ensure the longevity and optimal performance of the system. This proactive approach will minimize the risk of damage or deterioration caused by excessive water exposure and promote a healthier and more stable environment for the rails/joists.



## **HAZARDS IDENTIFICATION**

The major hazards associated with these products are primarily physical, with a focus on manual handling. It is important to note that sparks can be generated during cutting processes.

When working with aluminium or steel, it is recommended to use high-quality saws and drills to minimize the production of particles and sparks. Even though aluminium and lightweight steel is relatively easy to cut, using appropriate tools will help reduce the risk of sparks.

To ensure safety, it is essential to wear proper protective clothing and equipment when handling and cutting aluminium. This includes full coverage eye protection, which is particularly important. By utilizing the appropriate safety gear, you can mitigate the potential risks associated with handling and cutting aluminium.

## **FIRST-AID MEASURES**

In case of cuts, it is important to thoroughly wash the wound with ample clean water. Afterward, it is advisable to seek immediate medical attention. Tetanus is a potential concern, so prompt medical evaluation is crucial.

If you experience skin, eye, or respiratory irritation, it is important to seek medical attention as soon as possible. This is especially necessary if you are experiencing any eye irritation.

Prompt medical evaluation will help address any potential issues and ensure appropriate treatment for the symptoms you are experiencing.

## **FIRE-FIGHTING MEASURES**

All of components achieve fire resistance Class A according to standard BS EN 3501-01 : 2018, so they pose no fire risk. Therefore, it can be easily installed in public areas and does not constitute a fire hazard. Use extinguishing media appropriate to the surrounding fire conditions.

These pedestals and rail headpiece do not constitute a fire hazard. Use extinguishing media appropriate to the surrounding fire conditions.

## **HAZARD**

As supplied, the products are not classified as hazardous.



## **HANDLING AND STORAGE**

When handling these components, it is essential to consider the risks outlined in the Manual Handling Operations Regulations 1992, and appropriate personal protective equipment (PPE) should be used. The products will be delivered secured onto pallets, and it is important to utilize suitable lifting equipment operated by qualified personnel when moving the pallets.

To ensure safe storage, they should be stored in a stable manner. It is recommended to store aluminium rails flat and avoid standing them up against a vertical surface, as this can lead to damaging of the profile which may cause issues with fittings and fixtures.

During the cutting process, it is crucial to implement measures to control metal particles and ensure proper ventilation. Additionally, always wear appropriate respiratory and full covered eye protection to safeguard against potential hazards.

## **DISPOSAL CONSIDERATIONS**

Recycling aluminium rails at the end of their life cycle is strongly recommended. Aluminium is a highly recyclable material, and recycling helps conserve resources and reduce environmental impact. By recycling aluminium rails, the material can be processed and used to create new products, reducing the need for virgin aluminium extraction and production.

When it comes to the disposal of aluminium rails, they can be taken to an approved solid waste disposal site. These sites are equipped to handle various types of waste materials, including metals like aluminium. Proper disposal ensures that the rails do not end up in landfills or contribute to environmental pollution.

However, it is important to note that the disposal process should adhere to local or national regulations. Different regions may have specific guidelines and requirements for the disposal of certain materials, including aluminium. These regulations are in place to protect the environment and human health.

To ensure compliance, it is recommended to consult the relevant local or national authorities or waste management agencies for specific guidance on the proper disposal of aluminium rails. They can provide information on designated disposal facilities, recycling programs, or any special instructions that need to be followed.

By following the appropriate local or national regulations for disposal, you can contribute to responsible waste management and help minimize the environmental impact of aluminium rail disposal.



## **WARRANTIES**

A Limited Warranty exists that the products will comply with the test data as laid out in this document for a period of 15 Years. Warranty is limited to replacement of products which have been installed in the correct manner and for the correct purpose only. Warranty is limited to the value of the cost price of the materials only, not replacement costs or any other labour cost.

Under no circumstances shall Wallbarn Ltd be held responsible or liable for any incidental, consequential, indirect, special, punitive or any other damage (including, but not limited to, loss of profits, loss of sales, loss of start-up, loss or reduction of work).

This Limited Warranty covers our pedestals on condition that the Installation and Care & Maintenance Instructions are followed, and are installed according to Wallbarn Ltd guidelines.

See Terms and Conditions of the Warranty and Scope of the Guarantee below for other exclusions and limitations of this Warranty.

### **1) WARRANTY TERMS AND CONDITIONS**

1.1 Complaints are physically examined by Wallbarn Ltd.

1.2 Complaints / claims should be filed in writing to Wallbarn Ltd.

1.3 Proof of purchase of the rails/joists should accompany the written complaint / claim. Complaints / claims without the appropriate documentation will not be considered.

1.4 The company examining complaints (or its representatives) reserves the right to check the pedestals in the place of installation, the manner they have been installed and obtain details of the care and maintenance programme carried out before giving considering to the complaint/claim.

1.5 The complaint / claim is only valid if the products are installed in the territory that the original purchase was made.

1.6 Wallbarn Ltd reserves the right to either repair the defect or to offer material free of charge to the customer.

The above guaranteed lifetime of the pedestal exists only where the Products have been installed in the correct and proper manner.



## **2) VISUAL APPEARANCE WARRANTY ON DELIVERY**

Each pedestal is carefully inspected by our quality control team personnel prior to leaving our factory to ensure they are defect free. We urge Customers and the installers to inspect each pedestal prior to installation. This Limited Warranty does not extend to cover defects in pedestals on delivery after installation has taken place.

## **3) SCOPE OF GUARANTEE**

3.1 This guarantee is issued in accordance with and is subject to the laws of England & Wales.

3.2 Obvious defects in the pedestal should be communicated to the supplier within 30 days from the delivery date of goods on site/warehouse. Claims regarding obvious defects after this period will not be considered.

3.3 To be able to make use of the Warranty the product – Mega Balance Pedestals- must be installed according to the Installation Instructions. Use fixings recommended and approved by Wallbarn Ltd as indicated in the appropriate technical documentation. The use of other types of fixtures not provided or approved by Wallbarn Ltd invalidates this Warranty.

3.4 If a claim is granted before installing the material, faulty pedestals are replaced free of charge.

3.5 No claims can be accepted after installing the material if the buyer could have detected the defects before installation. This Warranty does not cover damage caused by third parties before installation.

## **TRANSPORT INFORMATION**

The best method of transportation is strapped securely onto pallets.





## KEY CONTACTS

Wallbarn Ltd.

Unit 16 Capital Business Centre,  
22 Carlton Road,  
South Croydon CR2 0BS

Tel: +44 (0)20 8916 2222

Fax: +44 (0)20 8916 2223

Email: [sales@wallbarn.com](mailto:sales@wallbarn.com)

Web: [www.wallbarn.com](http://www.wallbarn.com)

## APPENDIX A

The following table summarizes the products referenced in this document:

Product	URL
MetalPad Ex Pedestal	<a href="https://www.wallbarn.com/fire-rated/metalpad-ex/">https://www.wallbarn.com/fire-rated/metalpad-ex/</a>
Ultra Low Joist Holders	<a href="https://www.wallbarn.com/fire-rated/rail-holders/">https://www.wallbarn.com/fire-rated/rail-holders/</a>
Fire Rated Substructure	<a href="https://www.wallbarn.com/substructure/our-range/">https://www.wallbarn.com/substructure/our-range/</a>
Aluminium I-Plus Joist/Rail	<a href="https://www.wallbarn.com/substructure/i-plus-beam/">https://www.wallbarn.com/substructure/i-plus-beam/</a>
Aluminium Box Joist/Rail	<a href="https://www.wallbarn.com/substructure/box-rail/">https://www.wallbarn.com/substructure/box-rail/</a>



## APPENDIX B:

# LIMITED WARRANTY

Wallbarn Ltd provides a limited warranty of 15 years for products. This Warranty corresponds to the performance and strength characteristics given in the published technical datasheets.

Wallbarn Ltd warranties that, under normal use and service conditions, and where the products have been installed in the proper manner, Wallbarn Ltd products shall be free from material defects in workmanship and materials, shall not crack, splinter, swell, rot or suffer structural damage from damp or fungal decay.

If a defect occurs within the Warranty Period, the Purchaser shall notify Wallbarn Ltd in writing and, after investigation and confirmation of the defect(s) by a Wallbarn Ltd representative, Wallbarn Ltd's sole responsibility shall be limited to replacement of the affected products or to refund the Purchaser up to the maximum value of the Sales Invoice.

### **This warranty is null and void if:**

- The products are not installed in the proper manner as detailed in official Wallbarn Ltd product catalogues, installation guides and technical datasheets.
- The products are not used for the purposes they are intended, as detailed in official Wallbarn Ltd product catalogues, installation guides and technical datasheets.
- Excessive weights, higher than the maximum weight as detailed in official Wallbarn Ltd product catalogues, installation guides and technical datasheets are placed onto the products.
- The products are installed in contravention of any relevant building regulations, code or standards.
- Any relevant building regulations, code or standards, including fire safety regulations are breached on the project during the construction process.
- There is movement, distortion, collapse or settling of the supporting structure on which Wallbarn Ltd products are installed.
- Any abnormal natural event such as flooding, hurricane, earthquake, lightning, etc., occurs.



## Wallbarn Ltd – Limited Warranty

This limited warranty does not cover any living product or any product which sustains life. This includes sedum and other plants and substrate mixes for M-Tray® and any other green roof system. The living and growing elements of M-Tray® and other green roof systems are specifically excluded from this Warranty.

This Warranty is limited to the maximum amount of the Sales Invoice and Wallbarn Ltd is not liable for any costs of examination, removal or installation of products. Wallbarn Ltd will not be responsible for any costs or expenses incurred during removal and replacement, including labour or transport costs.

This warranty is given only if the products are used for the purposes they are intended, as detailed in official Wallbarn Ltd product catalogues, installation guides and technical datasheets and are installed in the correct manner.

To make a claim under this Limited Warranty, the Purchaser should contact Wallbarn Ltd with a full report of the defects within the Warranty Period, including photographic evidence and proof of purchase. Any claim should be made to [sales@wallbarn.com](mailto:sales@wallbarn.com) as soon as possible by the Purchaser.

Our Terms & Conditions of Supply can be found here  
<https://www.wallbarn.com/terms-conditions-of-supply/>

APPENDIX C:  
**TEST CERTIFICATE**  
LOAD TESTING IN ACCORDANCE WITH  
THE CLIENT'S SPECIFICATION



On Wallbarn Limited,  
3 Hagley Court North, The Waterfront, Dudley, West Midlands, DY5 1XF

**PROOF LOAD TESTING**  
**STS LABORATORY**

**TEST DESCRIPTION:** A weight tolerance test was conducted on various pedestals. Testing was completed using a jack to apply a vertical compressive load centre to the product, to confirm structural performance and determine load failure limit. All testing was carried out in accordance with the client's specification.

REF NO.:	DR-5744	DATE TESTED:	15 <sup>th</sup> May 2024
JOB NO.:	P10259	CERTIFICATE DATE:	24 <sup>th</sup> May 2024
CERTIFICATE NO.:	IC11714	SUPPLIER/SOURCE:	Client

<b>TEST DETAILS:</b>			
Product Tested:	Various Pedestal Samples (See table Below)	Item Condition:	New
Target Loads:	Failure	Ambient Temperature:	18°C
Test Location:	STS Laboratory	Procedure or Method:	Client's Specification

**TEST RESULTS:**

Test Product	Product Material	Load Achieved (kN)
26 – 35mm Pedestal	Steel	53.67
185 – 260mm Pedestal	Steel	49.86
26 – 35mm Pedestal with Spreader Plate	Steel	70.69
185 – 260mm Pedestal with Spreader Plate	Steel	129.53
10mm Fixed Height Pad	Aluminium	209.24

**ANALYSIS:**

Testing was completed with each individual pedestal obtaining failure loads. Following this, the highest load achieved at failure was the 10mm Fixed Height Pad, achieving a load of 209.24kN before failure. The 185 – 260mm Pedestal obtained the lowest load achieved, with 49.86kN before the product began to deform. All testing was completed within the client's specification.

For Specialist Technical Services (U.K) Limited			The results found on this Certificate relate only to the product[s] tested as described above This Test Certificate shall <u>not</u> be reproduced except in full  QC: TC001 – Test Certificate – v4.0   Page 1 of 1
Approved By:	Andrew Gore		
Position:	Technical Director		
Signature:			

END OF PAGE

Unit D4, Poole Hall Business Park, Poole Hall Road, Ellesmere Port, Cheshire, CH66 1UA, United Kingdom

T: +44 (0) 1244 794 104 F: +44 (0) 1244 794 204

E: [Info@sts-group.co.uk](mailto:Info@sts-group.co.uk)

Offices Located at: Chester | Ellesmere Port

Website: <https://www.sts-group.co.uk>



APPENDIX D:

TEST CERTIFICATE  
LOAD TESTING IN ACCORDANCE WITH  
BS 8579:2020



On Wallbarn Limited,  
3 Hagley Court North, The Waterfront, Dudley, West Midlands, DY5 1XF

**PROOF LOAD TESTING**  
**STS LABORATORY**

**TEST DESCRIPTION:** A weight tolerance test was conducted on various aluminium rails fitted to steel pedestals, increasing in 100mm spans from the centre of the rail. Testing was completed using a jack to apply a vertical compressive load centre to the product, to confirm structural performance. Loading results obtained were recorded at the limit of 5mm deflection. All testing was carried out in accordance with the client's specification.

REF NO.: DR-5744 DATE TESTED: 15<sup>th</sup> May 2024  
JOB NO.: P10259 CERTIFICATE DATE: 24<sup>th</sup> May 2024  
CERTIFICATE NO.: IC11716 SUPPLIER/SOURCE: Client

**TEST DETAILS:**  
Product Tested: Aluminium Rail with Steel Pedestal Item Condition: New  
Target Loads: 5mm Deflection Ambient Temperature: 18°C  
Test Location: STS Laboratory Procedure or Method: BS 8527:2020

**TEST RESULTS:**

Test Product	Load Achieved (kN)											
	100mm from Centre	200mm from Centre	300mm from Centre	400mm from Centre	500mm from Centre	600mm from Centre	700mm from Centre	800mm from Centre	900mm from Centre	1000mm from Centre	1100mm from Centre	1200mm from Centre
15mm Rail	2.04	2.08	2.01	1.13								
20mm Rail	2.02		2.03	1.98								
50mm Rail			2.10	1.54	1.43	1.40	1.28					
75mm Rail			2.26	2.03	2.01	1.97	1.90	1.88	1.78	1.28		
100mm Rail			2.02	2.05	2.05	2.05	2.05	2.02	2.00	2.05	2.02	1.90

**ANALYSIS:**  
Testing was completed with each individual rail obtaining various loads before reaching 5mm deflection. The 15mm & 20mm rail reached a 400mm span before the maximum deflection was obtained, with the 100mm rail reaching a span of 1200mm from the centre, before obtaining maximum permissible deflection. All testing was completed within the BS 8572:2020.

<b>For Specialist Technical Services (U.K) Limited</b>			The results found on this Certificate relate only to the product[s] tested as described above This Test Certificate shall <u>not</u> be reproduced except in full  QC: TC001 – Test Certificate – v4.0   Page 1 of 1
Approved By:	Andrew Gore		
Position:	Technical Director		
Signature:			

END OF PAGE

Unit D4, Poole Hall Business Park, Poole Hall Road, Ellesmere Port, Cheshire, CH66 1UA, United Kingdom  
T: +44 (0) 1244 794 104 F: +44 (0) 1244 794 204  
E: Info@sts-group.co.uk

Offices Located at: Chester | Ellesmere Port  
Website: <https://www.sts-group.co.uk>



## APPENDIX E:

# TEST CERTIFICATE

## LOAD TESTING IN ACCORDANCE WITH THE CLIENT'S SPECIFICATION



On Wallbarn Limited,  
3 Hagley Court North, The Waterfront, Dudley, West Midlands, DY5 1XF

### PROOF LOAD TESTING STS LABORATORY

**TEST DESCRIPTION:** A weight tolerance test was conducted on various aluminium rails to determine the destructive load obtainable. Testing was completed using a jack to apply a vertical compressive load centre to the product, to confirm structural performance and determine load failure limit. All testing was carried out in accordance with the client's specification.

REF NO.:	DR-5744	DATE TESTED:	15 <sup>th</sup> May 2024
JOB NO.:	P10259	CERTIFICATE DATE:	24 <sup>th</sup> May 2024
CERTIFICATE NO.:	IC11717	SUPPLIER/SOURCE:	Client

#### TEST DETAILS:

Product Tested:	Aluminium Rail	Item Condition:	New
Target Loads:	Failure	Ambient Temperature:	18°C
Test Location:	STS Laboratory	Procedure or Method:	Client's Specification

#### TEST RESULTS:

Test Product	Load Obtained (kN)	Maximum Displacement (mm)
15mm Rail	1.05	68.77
20mm Rail	1.06	65.87
25mm Rail	1.58	64.63
50mm Rail	4.08	44.96
75mm Rail	6.58	32.65
100mm Rail	8.10	27.86

#### ANALYSIS:

Testing was completed with each individual rail obtaining various loads before reaching failure. The 15mm rail obtained the lowest load (1.05kN) along with the highest displacement (68.77mm), with the 100mm obtaining the highest loading (8.10kN) along with the lowest recorded displacement (27.86mm). All testing was completed within the client's specification.

<b>For Specialist Technical Services (U.K) Limited</b>			The results found on this Certificate relate only to the product[s] tested as described above This Test Certificate shall <u>not</u> be reproduced except in full  QC: TC001 – Test Certificate – v4.0   Page 1 of 1
Approved By:	Andrew Gore		
Position:	Technical Director		
Signature:			

END OF PAGE

Unit D4, Poole Hall Business Park, Poole Hall Road, Ellesmere Port, Cheshire, CH66 1UA, United Kingdom

T: +44 (0) 1244 794 104 F: +44 (0) 1244 794 204

E: Info@sts-group.co.uk

Offices Located at: Chester | Ellesmere Port

Website: <https://www.sts-group.co.uk>



**TEST CERTIFICATE**LOAD TESTING IN ACCORDANCE WITH  
BS 8579:2020

On Wallbarn Limited,  
3 Hagley Court North, The Waterfront, Dudley, West Midlands, DY5 1XF

**PROOF LOAD TESTING**  
**STS LABORATORY**

**TEST DESCRIPTION:** A weight tolerance test was conducted on dual 75mm aluminium rails at 1300mm overall span. Testing was completed using a jack to apply a vertical compressive load centre to the product, to confirm structural performance. Loading results obtained were recorded at the limit of 5mm deflection. All testing was carried out in accordance with the client's specification.

REF NO.:	DR-5744	DATE TESTED:	18 <sup>th</sup> July 2024
JOB NO.:	P10259	CERTIFICATE DATE:	23 <sup>rd</sup> July 2024
CERTIFICATE NO.:	IC11786	SUPPLIER/SOURCE:	Client

**TEST DETAILS:**

Product Tested:	Dual 75mm Aluminium Rail	Item Condition:	New
Target Loads:	5mm Deflection	Ambient Temperature:	19°C
Test Location:	STS Laboratory	Procedure or Method:	BS 8527:2020

**TEST RESULTS:**

Product	Bearing Span (mm)	Load Achieved at 5mm Deflection (kN)
75mm Rail	1300	2.75

**ANALYSIS:**

Testing was completed with the dual rail obtaining a load of 2.75kN per rail at a deflection of 5mm. All testing was completed within the BS 8572:2020.

<b>For Specialist Technical Services (U.K) Limited</b>			<p>The results found on this Certificate relate only to the product[s] tested as described above This Test Certificate shall <u>not</u> be reproduced except in full</p> <p align="right">QC: TC001 – Test Certificate – v4.0   Page 1 of 1</p>
Approved By:	Andrew Gore		
Position:	Technical Director		
<b>Signature:</b>			

END OF PAGE

Unit D4, Poole Hall Business Park, Poole Hall Road, Ellesmere Port, Cheshire, CH66 1UA, United Kingdom  
T: +44 (0) 1244 794 104 F: +44 (0) 1244 794 204  
E: Info@sts-group.co.uk

Offices Located at: Chester | Ellesmere Port  
Website: <https://www.sts-group.co.uk>



# TEST CERTIFICATE

## LOAD TESTING IN ACCORDANCE WITH BS 8579:2020



On Wallbarn Limited,  
3 Hagley Court North, The Waterfront, Dudley, West Midlands, DY5 1XF

### PROOF LOAD TESTING STS LABORATORY

**TEST DESCRIPTION:** A weight tolerance test was conducted on an aluminium rail with steel pedestals at two different lengths apart one was 2700mm and the other 3100mm. Testing was completed using a jack to apply a vertical compressive load centre to the product, to confirm structural performance. Loading results obtained were recorded at the limit of 5mm deflection. All testing was carried out in accordance with the client's specification.

REF NO.:	DR-5838	DATE TESTED:	30 <sup>th</sup> October 2024
JOB NO.:	P10305	CERTIFICATE DATE:	31 <sup>st</sup> October 2024
CERTIFICATE NO.:	IC11898	SUPPLIER/SOURCE:	Client

<b>TEST DETAILS:</b>			
Product Tested:	100mm Aluminium Rails with Steel Pedestal	Item Condition:	New
Target Loads:	5mm Deflection	Ambient Temperature:	18°C
Test Location:	STS Laboratory	Procedure or Method:	BS 8579:2020

#### TEST RESULTS:

Tests	Load (kN) at 2700mm	Load (kN) at 3100mm	Classification
1	2.69	2.07	Pass



#### ANALYSIS:

Testing was completed with both lengths achieving a deflection of 5mm while having a permanent deflection of 0.12mm for 2700mm and 0.46mm for 3100mm. All testing was completed within the BS 8579:2020.

For Specialist Technical Services (U.K) Limited			<p>The results found on this Certificate relate only to the product[s] tested as described above This Test Certificate shall <u>not</u> be reproduced except in full</p> <p>QC: TC001 – Test Certificate – v4.0   Page 1 of 1</p>
Approved By:	Andrew Gore		
Position:	Technical Director		
Signature:			

END OF PAGE

Unit D4, Poole Hall Business Park, Poole Hall Road, Ellesmere Port, Cheshire, CH66 1UA, United Kingdom  
T: +44 (0) 1244 794 104 F: +44 (0) 1244 794 204  
E: Info@sts-group.co.uk

Offices Located at: Chester | Ellesmere Port  
Website: <https://www.sts-group.co.uk>





**TEST CERTIFICATE**  
**LOAD TESTING IN ACCORDANCE WITH**  
**THE CLIENT'S SPECIFICATION**



On Wallbarn Limited,  
 3 Hagley Court North, The Waterfront, Dudley, West Midlands, DY5 1XF

**PROOF LOAD TESTING**  
**STS LABORATORY**

**TEST DESCRIPTION:** A destruction test was conducted on an aluminium rail. Testing was completed using a hydraulic jack to apply a vertical point load to the centre of the product. All testing was carried out in accordance with the client's specification.

<b>REF NO.:</b>	DR-5838	<b>DATE TESTED:</b>	5 <sup>th</sup> November 2024
<b>JOB NO.:</b>	P10305	<b>CERTIFICATE DATE:</b>	6 <sup>th</sup> November 2024
<b>CERTIFICATE NO.:</b>	IC11907	<b>SUPPLIER/SOURCE:</b>	Client

<b>TEST DETAILS:</b>			
Product Tested:	25mm Aluminium Rail	Item Condition:	New
Target Loads:	Failure	Ambient Temperature:	22°C
Test Location:	STS Laboratory	Procedure or Method:	Client's Specification

**TEST RESULTS:**

Test Product	Load Achieved (kN)	Displacement (mm)
25mm rail	5.14	62.66



**ANALYSIS:**

Testing was completed with the rail reaching a maximum load of 5.14kN before suffering permanent deformation. All testing was completed within the Client's Specification.

<b>For Specialist Technical Services (U.K) Limited</b>			The results found on this Certificate relate only to the product[s] tested as described above This Test Certificate shall <u>not</u> be reproduced except in full  QC: TC001 – Test Certificate – v4.0   Page 1 of 1
<b>Approved By:</b>	Andrew Gore		
<b>Position:</b>	Technical Director		
<b>Signature:</b>			

END OF PAGE



# TEST CERTIFICATE

## LOAD TESTING IN ACCORDANCE WITH BS 8579:2020



On Wallbarn Limited,  
3 Hagley Court North, The Waterfront, Dudley, West Midlands, DY5 1XF

### PROOF LOAD TESTING STS LABORATORY

**TEST DESCRIPTION:** A proof load test was conducted on a 25mm aluminium rail, with steel pedestals fitted at varied lengths, increasing in 100mm spans from the centre of the rail. Testing was completed using a hydraulic jack to apply a vertical point load to the centre of the product. All testing was carried out in accordance with British Standard BS 8579:2020.

<b>REF NO.:</b>	DR-5838	<b>DATE TESTED:</b>	5 <sup>th</sup> November 2024
<b>JOB NO.:</b>	P10305	<b>CERTIFICATE DATE:</b>	6 <sup>th</sup> November 2024
<b>CERTIFICATE NO.:</b>	IC11902	<b>SUPPLIER/SOURCE:</b>	Client

<b>TEST DETAILS:</b>			
Product Tested:	Aluminium Rail with Steel Pedestal	Item Condition:	New
Target Loads:	2.0kN	Ambient Temperature:	22°C
Test Location:	STS Laboratory	Procedure or Method:	BS 8527:2020

#### TEST RESULTS:

Test Product	Load Achieved (kN)		
	300mm from Centre	400mm from Centre	500mm from Centre
25mm Rail	2.46	2.06	1.48



#### ANALYSIS:

Testing was completed with the rail obtaining 2kN load before reaching 5mm deflection. The rail managed to get to 400mm before failing at 500mm, which got to 1.48kN at the 5mm maximum deflection. All testing was completed within the BS 8572:2020.

<b>For Specialist Technical Services (U.K) Limited</b>		 The results found on this Certificate relate only to the product[s] tested as described above This Test Certificate shall <u>not</u> be reproduced except in full QC: TC001 – Test Certificate – v4.0   Page 1 of 1
<b>Approved By:</b>	Andrew Gore	
<b>Position:</b>	Technical Director	
<b>Signature:</b>		

END OF PAGE

Unit D4, Poole Hall Business Park, Poole Hall Road, Ellesmere Port, Cheshire, CH66 1UA, United Kingdom  
 T: +44 (0) 1244 794 104 F: +44 (0) 1244 794 204  
 E: Info@sts-group.co.uk

Offices Located at: Chester | Ellesmere Port  
 Website: <https://www.sts-group.co.uk>





# Reaction to fire classification report

Issuing laboratory: Warringtonfire Testing and Certification Limited

Classification standard: EN 13501-1: 2018

Sponsor(s): Wallbarn Ltd

Product(s): "Zintek 200"

Report number: 544697

Version: 1

Warringtonfire Testing and Certification Limited , accredited for compliance with ISO/IEC 17025:2017 – Testing

## Quality management

Version	Date	Summary of amendments including reasons			
1	10 September 2024	Description	Initial issue		
			Prepared by	Reviewed by	Authorised by
		Name	Tracy Deluce	Leslie Berry	Stacey Deeming
		Signature			
*Signed for and on behalf of Warringtonfire Testing and Certification Limited					

## Contents

Quality management	2
1. Introduction	4
2. Details of classified product	4
2.1 2.2 General	4
3. Product description	4
3.1 3.2 Test reports and test results in support of classification	5
3.2.1 Test reports	5
3.2.1 Official test results used for the classification	6
3.2.2 Test results	6
	6
	7
4. Classification and field of application	7
4.1 Reference of classification	7
4.2 Classification	7
4.3 Field of application	8
4.4 Fire performance parameters for A2 - s1, d0	9
5. Restrictions	9
6. Limitations	10
7. Validity	

## 1. Introduction

This classification report defines the classification assigned to "Zintek 200", in line with the procedures given in EN 13501-1: 2018.

Warringtonfire Testing and Certification Limited (Warringtonfire) issued the classification report at the request of the sponsor listed in Table 1.

**Table 1 Sponsor details**

Entity	Address
<b>Sponsor</b>	
Wallbarn Ltd	Unit 16 Capital Business Park, 22 Carlton Road, South Croydon, CR2 0BS, United Kingdom

## 2. Details of classified product

### 2.1 General

The product, "Zintek 200", is defined as being suitable for construction applications excluding flooring and linear pipe thermal insulation applications.

### 2.2 Product description

The product, "Zintek 200", is described in Table 2 and in the test reports listed in Section 3.1.

**Table 2 Product description**

Item		Detail
General description		Coated steel sheet
Product reference of overall composite		"Zintek 200"
Name of manufacturer		MetalFloor (Steel manufacturer) Atotech (coating material manufacturer) AST (applicator)
Overall thickness (coated steel)		1.55-1.62mm (stated by sponsor) 1.49mm (determined by Warringtonfire)
Overall weight per unit area (coated steel)		11.33kg/m <sup>2</sup> (stated by sponsor) 11.33kg/m <sup>2</sup> (determined by Warringtonfire)
Coating	Generic type	An inorganic, zinc rich corrosion protective base coating material made with zinc and aluminium flakes.
	Product reference	"Zintek 200"
	Name of manufacturer	Atotech
	Colour	Silver
	Number of layers	1
	Overall thickness	0.05-0.12mm
	Application rate	<sup>2</sup> 30g/m
	Specific gravity	See Note 1 below
	Application method	Spray
	Curing process	Oven cure 40 mins, at 220°C
	Flame retardant details	See Note 2 below

Continued on next page

Item		Detail
Steel	Generic type	Steel plate
	Product reference	"MetalPad EX "
	Name of manufacturer	MetalFloor
	Thickness	1.5mm
	Weight per unit area	11.7kg/m <sup>2</sup>
	Flame retardant details	See Note 2 below
Brief description of manufacturing process		Steel coated with 'Zintec 200', an inorganic, zinc rich corrosion protective base coating material made with zinc and aluminium flakes.
Mounting and fixing details		The coated steel was tested over a 12mm thick calcium silicate substrate as defined in EN 13238:2010

Note 1: The sponsor was unable to provide this information.

Note 2: The sponsor of the test has confirmed that no flame retardant additives were utilised in the production of the component.

### 3. Test reports and test results in support of classification

#### 3.1 Test reports

Table 3 details the test reports that have been used in support of classification.

**Table 3 Test reports**

of laboratory	Name of sponsor(s)	Test report no.	Test date	Test and extended application standard
Warringtonfire	Wallbarn Ltd	544691 (Issue 2)	14 June 2024	EN 13823: 2020 + A1: 2022
Warringtonfire	Wallbarn Ltd	544692 (Issue 2)	19 June 2024	EN ISO 1716: 2018 (*)

(\*) As the test procedure for EN ISO 1716 remained identical for versions 2010 & 2018 and no substantial technical changes were noticed in the most recent version 2018, results obtained with the 2018 version can also be considered valid for classification purposes (where only the 2010 version is mentioned).

## 3.2 Test results

### 3.2.1 Official test results used for the classification

Table 4 details the test results that have been used in support of classification. The fire performance parameters for class A2 - s1, d0 can be found in Table 5.

Table 4 Test data

Test method Report number	Parameter	Number of tests	Results	
			Continuous parameters	Compliance with parameters
EN 13823: 2020 + A1: 2022 544691 (Issue 2)	FIGRA (THR(t) threshold of 0.2MJ)		0	-
	FIGRA (THR(t) threshold of 0.4MJ)		0	-
	THR600s (MJ)		0.2	-
	LFS < edge of specimen		-	Compliant
	SMOGRA (m <sup>2</sup> /s <sup>2</sup> )		0	-
	TSP600s (m <sup>2</sup> )		5 -	- Compliant
	No flaming droplets/particles persisting shorter than 10 s in EN 13823 within 600s			
	No flaming droplets/particles persisting longer than 10 s in EN 13823 within 600s		-	Compliant
EN ISO 1716: 2018 544692 (Issue 2)	Average gross heat of combustion, QPCS (MJ/m <sup>2</sup> ) of external non-substantial component on non-homogeneous product Coating	3	0.3	-
EN ISO 1716: 2018 N/A	Average gross heat of combustion of substantial component, of non-homogeneous product, QPCS (MJ/kg) Steel	-	0.0	-
Product as a whole, QPCS (MJ/kg)			0.0	

Note: '-' symbol confirms this parameter is not applicable.



## 4. Classification and field of application

### 4.1 Reference of classification

This classification has been carried out in accordance with EN 13501-1:2018.

### 4.2 Classification

The product "Zintek 200" in relation to its reaction to fire behavior is classified as:

A2

The additional classification in relation to smoke production is:

s1

The additional classification in relation to flaming droplets / particles is:

d0

The format of the reaction to fire classification for construction applications excluding flooring and linear pipe thermal insulation applications products is:

Fire behaviour		Smoke production		Flaming droplets
A2	-	s	1	, d 0

Alternatively shown:

**Reaction to fire classification: A2 - s1, d0**

### 4.3 Field of application

The classification for the product described in Section 2.2 of this report is valid for end use applications described in Table 5.

End use	Description	Origin
Substrate	Any substrate with a density equal to or greater than 652.5 kg/m <sup>3</sup> , a minimum thickness of 9 mm and a fire performance of A2-s1, d0 or better (excluding paper faced gypsum plasterboard).	As per EN 13238: 2010, clause 5.3 and EGOLF recommendation 045-2018.
Airgap	None allowed	N/A

This classification is valid for the following product parameters:

- Overall thickness: 1.55-1.62mm (no variation allowed)
- Overall weight per unit area: 11.33kg/m<sup>2</sup>(no variation allowed)
- Coating thickness: 0.05 – 0.12mm (no variation allowed)
- Coating application rate: 30g/m<sup>2</sup>(no variation allowed)
- Number of layers of coating: One (no variation allowed)
- Coating application method: Spray (no variation allowed)
- Coating curing process: Oven cure 40 mins, at 220°C (no variation allowed)
- Coating colour: Silver (no variation allowed)
- Steel thickness: 1.5mm (no variation allowed)
- Steel weight per unit area: 11.7kg/m<sup>2</sup> (no variation allowed)
- Use of flame retardants: No variation allowed
- Construction: No variation allowed
- Composition: No variation allowed

#### 4.4 Fire performance parameters for A2 - s1, d0

All the products described in Section 2.2 and within the field of application defined in Section 4.3 comply with the fire performance parameters shown in Table 5. The test results can be found in Section 3.2.

**Table 5 Fire performance parameters for A2 - s1, d0**

Test method	Parameter	Continuous parameters	Compliance with parameters
EN 13823: 2020 + A1: 2022	FIGRA (THR(t) threshold of 0.2MJ)	FIGRA <sub>0,2MJ</sub> ≤ 120 W/s	-
	FIGRA (THR(t) threshold of 0.4MJ)	-	-
	THR600s (MJ)	THR600s ≤ 7,5 MJ	-
	Lateral flame spread to edge of test specimen?	-	LFS < edge of specimen
	SMOGRA (m <sup>2</sup> /s <sup>2</sup> )	SMOGRA ≤ 30m <sup>2</sup> /s <sup>2</sup>	- -
	TSP600s (m <sup>2</sup> )	TSP600s ≤ 50m <sup>2</sup>	No flaming droplets/particles persisting shorter than 10 s in EN 13823 within 600s
	Fall of flaming droplets/particles < 10s?	-	No flaming droplets/particles persisting longer than 10 s in EN 13823 within 600s
	Fall of flaming droplets/particles > 10s?	-	-

Continued on next page

Test method	Parameter	Continuous parameters	Compliance with parameters
EN ISO 1716: 2018	Average gross heat of combustion for substantial components of non-homogenous products, QPCS (MJ/kg)	$PCS \leq 3,0 \text{ MJ/kg}$	-
	Average gross heat of combustion per unit area for any external non-substantial component of non-homogenous products, QPCS (MJ/m <sup>2</sup> )	$PCS \leq 4,0 \text{ MJ/m}^2$	-
	For the product as a whole, (MJ/kg)	$PCS \leq 3,0 \text{ MJ/kg}$	-

Note: '-' symbol confirms this parameter is not applicable.

## 5. Restrictions

At the time the standard EN 13501-1: 2018 was published, no decision was made about the duration of validity of a classification report.

When this report is used to support UKCA marking under the Construction Products Regulation 2011 (retained EU law EUR 2011/305) as amended by the Construction Products (Amendment etc.) (EU Exit) Regulations 2019 and the Construction Products (Amendment etc.) (EU Exit) Regulations 2020 and/or 'CE+UK(NI)' marking for Northern Ireland under the Regulation 305/2011/EU of the European Parliament and of the Council of 9 March 2011, the provisions of those regulations prevail over any conflicting provisions in the designated/harmonised standards and technical specifications.

## 6. Limitations

According to the information mentioned by the sponsor on the technical information sheet there was no harmonised product standard for UKCA or CE+UK(NI) marking available at the time the classification report for the tested material/product was drafted. When such a product standard is published, this report may be submitted again to the laboratory to evaluate the adequacy of the report for UKCA or CE+UK(NI) marking.

The test laboratory played no part in sampling the product for the test, although it holds appropriate references, supplied by the manufacturer, to provide evidence for the traceability of the samples tested.

## 7. Validity

This document is the original version of this classification report and is written in English. In case of doubt the original version prevails over a translation.

This document is issued subject to Warringtonfire's standard terms and conditions, which are available at: [Terms and Conditions | Element](#).

The classification results relate to the behaviour of a product under the particular conditions of the test(s); they are not intended to be the sole criterion for assessing the potential fire hazard of the product in use, nor can the classification results be extrapolated and applied to other products, or imply suitability for use in configurations not specifically detailed in the classification report. The classification is based on the information available to Warringtonfire at the time of the report. Should conflicting or contradictory evidence become available, Warringtonfire reserves the right to unconditionally withdraw the classification report forthwith upon giving written notice of the same.

Reports are statements of fact prepared in accordance with the referenced version of the standards stated in Section 3 of this report. Test, classification and extended application are based upon the information provided to Warringtonfire. Warringtonfire takes no responsibility for the accuracy or completeness of such information.

The results stated in this classification report apply to the test specimens as received and/or specified in the referenced/supporting test reports. Any differences in composition, production process, thickness, density or colour of the product may significantly affect the performance and will therefore invalidate the application of the test and classification results to the variant product. It is recommended that any proposed variation to the tested configuration or product should be referred to the sponsor. The sponsor should then obtain appropriate documentary evidence of compliance from Warringtonfire or another accredited testing authority. The supplier of the product is responsible for ensuring that the product which is supplied for use is identical to the test specimens that were tested.

This report may only be reproduced in full. Extracts or abridgements shall not be published without the express written permission of Warringtonfire.

The report is issued for the benefit of Warringtonfire's direct customer only, and may not be relied upon by any third parties without Warringtonfire's express written consent.

This document does not represent type approval or certification of the product. Warringtonfire does not give an opinion nor is it Warringtonfire's responsibility to determine or state whether the product meets any particular fire or life safety standards as set out in the Building Regulations or any other appropriate document.



**Registered office:**

**Warringtonfire Testing and Certification Limited**  
3rd Floor, Davidson Building, 5 Southampton Street, London, WC2E  
7HA, United Kingdom  
Registered Company No. 11371436

**Name & address of issuing laboratory:**

**Warringtonfire Testing and Certification Limited**  
Holmesfield Road, Warrington WA1 2DS, United Kingdom

**Reaction to Fire laboratory locations:**

**Ghent, Belgium**

BELAC accredited laboratory 196-TEST  
T: +32 9 243 77 50  
Notified Body Number 1173

**Warrington, United Kingdom**

a UKAS accredited testing laboratory No.0249  
T: +44 (0) 1925 655 116  
Approved Body Number 0833

**General conditions of use**

The data, methodologies, calculations and results documented in this report specifically relate to the tested specimen/s and must not be used for any other purpose. This report may only be reproduced in full. Extracts or abridgements must not be published without permission from Warringtonfire.

All work and services carried out by Warringtonfire are subject to, and conducted in accordance with, our standard terms and conditions. These are available on request or at <https://www.element.com/terms/terms-and-conditions>.

# Zintek® 200 XT

## Zinc flake coatings from Atotech



General Metal Finishing

Zinc flake coatings

atotech.com



## The neXT level base coat

### Premium silver base coat with high cathodic corrosion resistance

For a premium silver zinc flake base coat that maintains a shiny, bright, and attractive silver color, turn to MKS' Atotech Zintek® 200 XT. The base coat provides superb adhesion and is not prone to hydrogen embrittlement. When combined with MKS Atotech top coats, Zintek® 200 XT offers outstanding cathodic corrosion protection and staves off white rust formation. The base coat also demonstrates exceptional performance in Neutral Salt Spray Testing (NSST) as well as in Cyclic Corrosion Testing (CCT).

### Corrosion resistance

Base coat	Top coat	Durability
8 µm	-	>1,700 h*
8 µm	-	6 cycles**
10 µm	-	>2,000 h*

Corrosion resistance acc. to \*ISO 9227 / \*\*Ford L-467 and layer thickness may vary depending on part geometry, substrate and application method.

### Features and benefits

- Inorganic premium silver zinc flake base coat
- Outstanding cathodic corrosion protection
- Exceptional performance in NSST and Cyclic Corrosion Testing (CCT)
- Excellent delay in white rust formation
- High color stability
- Very good adhesion
- Attractive silver appearance
- No hydrogen embrittlement
- Free of harmful heavy metals such as Cr(VI), cadmium, cobalt, lead or nickel
- Combinable with MKS' Atotech top coats

# Zintek® 200 XT

## Zinc flake coatings from Atotech

### Application

---

- Dip-spin
- Rack-spin
- Spray

### Parts (application)

---

- Fasteners
- Chassis parts
- Stamping parts
- Brake components
- Springs
- Clips

### Coefficient of friction

---

- No defined coefficient of friction ( $\mu_{tot}$ )

### Corrosion performance (8 $\mu\text{m}$ layer thickness)



Start



>1,800 h\*



Start



6 cycles\*\*

### Top coat combinations

---

- With inorganic Zintek® Top
- With organic Techseal®
- With organic Techdip®

### Application parameters

---

- Application viscosity: 40 – 50 sec
- Curing time: 15 – 45 min
- Curing temperature: 220 – 260 °C
- Recommended 30 min at 250 °C object temperature

### Technical data

---

- Delivery density: 1.40 – 1.55 g/cm<sup>3</sup> (at 23 °C)
- Stability in sealed drums: 24 months
- Theoretical coverage rate: 25 m<sup>2</sup>/kg (based on 8  $\mu\text{m}$  dry film)

